



CORVETTE 2020



FOR ZORA ARKUS-DUNTOV

-

THE ORIGINAL CORVETTE CHIEF ENGINEER
WHO LIT AND NURTURED THE MID-ENGINE FLAME.

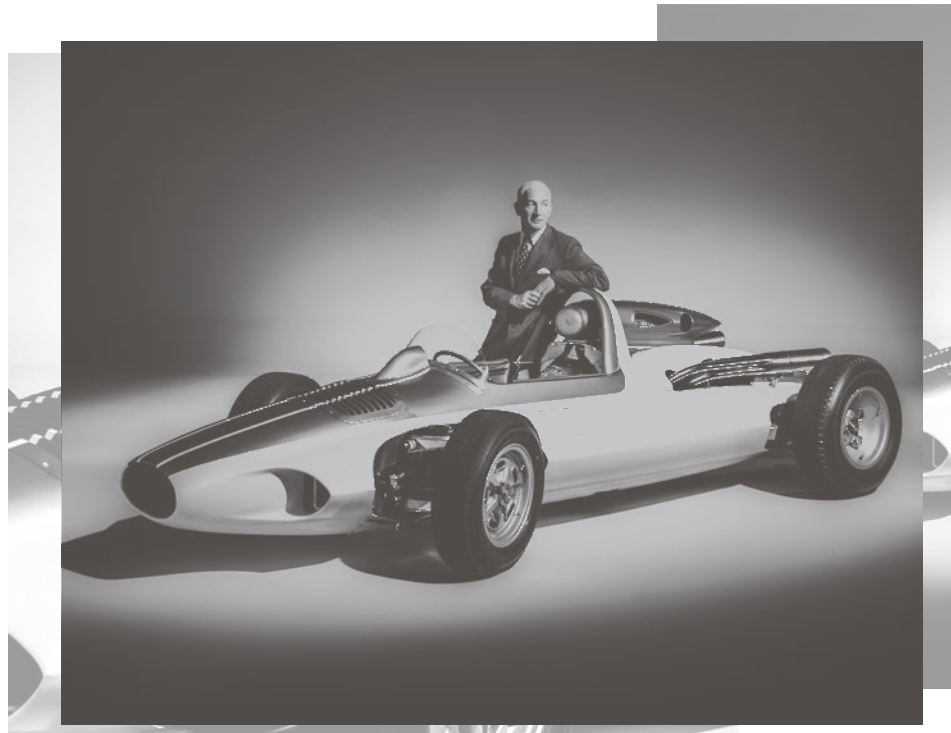

CORVETTE 

—

A DESTINY FULFILLED.

This is the moment we've been waiting for. The all-new mid-engine 2020 Corvette Stingray is here. When reinventing this iconic automobile, the creators broke barriers with a Corvette so advanced that the world of sports cars may never be the same. It is nothing less than the democratization of the supercar.

In naming the Stingray the 2020 *MotorTrend* Car of the Year,[™] the editors have declared: "The mid-engine Corvette is a game changer, an inflection point and a reminder that when Americans truly set our minds to a task, look out."



MOTORTREND
CAR OF THE YEAR 2020[®]
NORTH AMERICA

3LT COUPE WITH Z51 PERFORMANCE PACKAGE AND OPTIONS | TORCH RED



BENEFITS OF MID-ENGINE



—
THE MOVE

TO THE MIDDLE.

3LT COUPE WITH Z51 PERFORMANCE PACKAGE AND OPTIONS | TORCH RED

Why mid-engine? First, this puts the weight of the engine over the rear-driving wheels to enhance traction. With the engine located behind the cockpit, there's more forward visibility. And with the seats positioned closer to the front wheels, the driver and passenger are located at the car's center of gravity.

The result is instant response, a feeling that the car is rotating around you. With the extra traction on the rear wheels and nothing but the road ahead, you can dive quickly into a corner under braking and accelerate out smoothly. The Stingray is born to make your confidence soar.

DESIGN

—
NOT JUST A NEW CHAPTER.

IT'S A WHOLE NEW BOOK.

The mid-engine architecture dictated an all-new shape for Stingray with a polite nod to its proud heritage. Sweeping new proportions and a wide stance dominate your view. Function plays a huge role, with large front intakes and sculpted side intakes that help the engine breathe and stay cool. With the cockpit moved significantly forward, the side profile reveals a lower cowl with a long, graceful rear deck. The rear fascia features two functional air exits flanked by twin taillamps and twin exhaust outlets on each side, leaving no doubt about what you're driving.



3LT COUPE WITH OPTIONS | CERAMIC MATRIX GRAY METALLIC

DESIGN



“ LAID-BACK CRUISER,
FEROCIOUS TRACK ANIMAL. ”

— CAR AND DRIVER

3LT CONVERTIBLE WITH Z51 PERFORMANCE PACKAGE
AND OPTIONS | SEBRING ORANGE TINTCOAT (EXTRA COST)

DESIGN

—
2020 NORTH AMERICAN CAR OF THE YEAR.™



“ LEAVES THE AUTOMOTIVE LANDSCAPE
DIFFERENT THAN BEFORE. ”

— MOTORTREND

3LT COUPE WITH OPTIONS | CERAMIC MATRIX GRAY METALLIC
3LT COUPE WITH Z51 PERFORMANCE PACKAGE AND OPTIONS | RAPID BLUE (EXTRA COST)
3LT CONVERTIBLE WITH Z51 PERFORMANCE PACKAGE AND OPTIONS | BLADE SILVER METALLIC



—
**TAKING THE ART
OF DRIVING
TO A NEW LEVEL.**

**3LT INTERIOR WITH OPTIONS | JET BLACK WITH
AVAILABLE ADRENALINE RED CUSTOM STITCHING**

There's never been a Corvette cockpit this well-suited to enthusiast driving. Your driving position is some 16 inches forward compared to the previous generation, which puts you firmly in control. The low front cowl makes it even easier to see, while a racing-style steering wheel with paddle shifters keeps the view pure and also provides extra knee room.

Your rear sight lines are equally as impressive, thanks to an available Rear Camera Mirror.¹ Console controls include a push-button toggle switch gear selector and a leather-wrapped Driver Mode Selector. Finally, a flowing buttress is topped with easy-to-reach climate controls.

¹ Read the vehicle Owner's Manual for important feature limitations and information.

DESIGN



3LT COUPE WITH Z51 PERFORMANCE PACKAGE
AND OPTIONS | RAPID BLUE (EXTRA COST)



3LT CONVERTIBLE WITH Z51 PERFORMANCE PACKAGE
AND OPTIONS | SEBRING ORANGE TINTCOAT (EXTRA COST)

THE COUPE.

THE CONVERTIBLE.

When you first encounter a Stingray coupe, your eye is drawn to the powerful 6.2L V8 engine under glass. The coupe features a lightweight, easily removable roof panel that stows conveniently in the rear trunk. Choose from a standard body-color roof panel or available transparent or carbon-fiber versions.

For the first time ever, Corvette convertible features a production retractable hardtop that automatically folds neatly over the engine compartment in 16 seconds and can be operated at speeds up to 30 mph.

This hardtop retains the coupe's aerodynamic form and produces a similar drag coefficient with the top up. In the lowered position, the top does not intrude on trunk space. Track enthusiasts will be pleased to know that the new convertible with the top up meets the same standards as the coupe.

DESIGN

The Stingray was shaped and sculpted to consume massive amounts of air. A large air inlet dominates the side profile, providing vital breathing and cooling to the engine. The door releases are neatly hidden inside the inlet. The front sports large outboard air inlets that feed twin radiators just ahead of the front wheels.



3LT COUPE WITH Z51 PERFORMANCE PACKAGE AND OPTIONS | TORCH RED

ARCHITECTURE

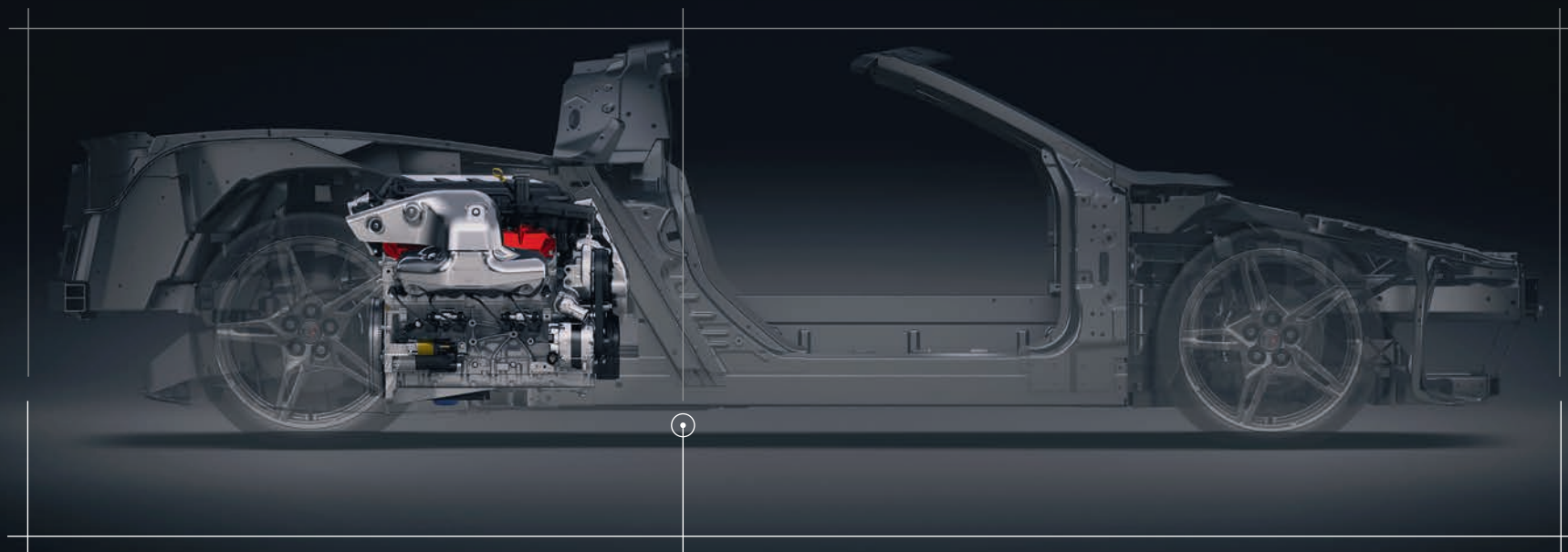

WEIGHT DISTRIBUTION

GREATNESS

REARRANGED.

For most of automotive history, engineers have sought a 50:50 weight distribution, especially for front-engine cars with rear-driving wheels. But Zora Arkus-Duntov declared a 40:60 front-to-rear weight ratio as ideal when he was developing the first Chevrolet mid-engine concept car – CERV I (Chevrolet Experimental Research Vehicle).

The all-new Stingray uses the same 40:60 front-to-rear weight ratio. Equally important, however, is the extraordinary rigidity of the structure itself, thanks to its architecture and materials. The Stingray structure is actually 54% stiffer than a Ferrari 458 Spider and 29% stiffer than a McLaren MP4-12C.

The secret is a closed center tunnel backbone conjoined by twin rails top and bottom. Many of the aluminum pieces are made with high-pressure die castings for extraordinary material properties, while others are made out of cast, forged or extruded aluminum. There is even a carbon-fiber rear bumper beam.

This rigid structure not only allows the all-new Stingray to change direction in heroic ways, but it also quickens acceleration times.

SUSPENSION



—

**THE CREDENTIALS
TO CONQUER
ANY CORNER.**

3LT COUPE WITH Z51 PERFORMANCE PACKAGE AND OPTIONS | TORCH RED

A TOTALLY NEW SUSPENSION GEOMETRY.

—

Lightning reflexes were mandatory. The eighth-generation Corvette features a modified SLA (short/long arm) suspension geometry as well as coil springs on all four corners of the car. This configuration keeps spring rates and damping low for comfort while enabling high-g cornering capability.

You can choose between the standard FE1 suspension or the available Z51 Performance Package. A new generation of Magnetic Selective Ride Control™ is available on Z51-equipped cars. The system integrates with the Driver Mode Selector to adjust ride stiffness in real time using magnetized ferrous particles in the shock fluid.

FRONT LIFT.

—

A new available front lift system can raise the front end almost 2 inches to help clear steep driveways, parking ramps or speed bumps. It lifts in less than 3 seconds at speeds below 24 mph and can be lowered manually or automatically afterward. And since it remembers up to 1,000 GPS locations, it works seamlessly within your world.





ENGINE

—
THE SOUL
OF
STINGRAY.

The heart of the all-new Stingray is a 6.2L LT2 aluminum small block V8 engine. Now in fifth-generation form, it is more compact yet more powerful: 490 standard horsepower and 465 lb.-ft. of torque. The available performance exhaust or the Z51 Performance Package add 5 more horsepower and 5 more lb.-ft. of torque, good for 0 to 60 mph in under 3 seconds¹. Much of the LT2's additional power can be attributed to excellent breathing. The intake system is a low-restriction design and incorporates identical 210 mm runners and an 87 mm throttle body. The performance header exhaust manifolds are also low-restriction and feature a stylized four-into-one design.

An all-new standard dry-sump oil system is integrated into the block and allows the engine to be positioned for a lower center of gravity. Three scavenging pumps capture circulating oil to ensure pressurized distribution even in the highest-g situations on the track.

¹Based on initial vehicle movement.



DUAL-CLUTCH TRANSMISSION

**LIGHTNING-FAST
AND EFFICIENT
SHIFTS.**

The control of a manual. The smoothness of an automatic. Yet it shifts faster than any human can, helping create the fastest-accelerating production Stingray ever. The new Corvette dual-clutch transmission is effectively two manual gearboxes that have clutches actuated by computers on a concentric shaft so there is no torque loss. There's a shaft for even gears 2-4-6-8-R and another for odd gears 1-3-5-7. The shifting schedule aligns to your chosen Driver Mode Selector position. As you shift via the paddles, you can simultaneously engage one shaft while you're disengaging another, giving you the ultimate feeling of control.



BRAKES



For the first time ever, Stingray uses an electro-hydraulic boost braking system. It adopts the proper pedal feel for each selected driving mode. It also helps reduce pad wear and brake pulsation.

Braking hardware includes Brembo® 4-piston front and rear calipers squeezing robust rotors. For the track, the available Z51 Performance Package includes monobloc 4-piston calipers for improved stiffness with larger rotors all around.

TIRES



MICHELIN® PILOT® SPORT ALL-SEASON TIRES

Great news for Corvette drivers who want standard summer tire performance with all-season capability. Michelin has created a custom Corvette application for its Pilot Sport all-season tire with the ability to achieve .94 g of lateral acceleration on a skid pad. If you crave even more capability, order the available Z51 Performance Package that includes standard Michelin Pilot Sport 4S summer-only tires¹ for even higher lateral grip on dry racetracks.

¹ Do not use summer-only tires in winter conditions, as it would adversely affect vehicle safety, performance and durability. Use only GM-approved tire and wheel combinations. Unapproved combinations may change the vehicle's performance characteristics. For important tire and wheel information, go to my.chevrolet.com/learnAbout/chevroleettires or see your dealer.

PERFORMANCE



3LT CONVERTIBLE WITH Z51 PERFORMANCE PACKAGE AND
OPTIONS | SEBRING ORANGE TINTCOAT (EXTRA COST)



Z MODE STEERING WHEEL BUTTON

—

THE RIGHT MODE FOR ANY ROAD.

Driving styles are individual. We have our preferences when it comes to shift points, steering effort, engine sound and braking feel. Bad weather or freezing conditions can also affect our choices. Six driving modes are available on Stingray, including four standard presets – Tour, Weather, Sport and Track – plus two new flexible modes. These include MyMode, which allows you to

create your own combination of presets for everyday use, and Z Mode, which lets you choose from a larger menu of high-performance settings for the engine, transmission and steering. It's great for a particular road or track, and you can engage it by pressing the Z button on the steering wheel.

PERFORMANCE

Z51

PERFORMANCE PACKAGE.



GO ALL IN.

3LT COUPE WITH Z51 PERFORMANCE PACKAGE AND OPTIONS | TORCH RED

The architecture, structure, suspension, calibrations and software of Stingray are all ready to deliver a driving experience beyond your imagination. But to reach the pinnacle, check the box for the available Z51 Performance Package. It provides a group of performance enhancements, including:

- Performance brakes with larger brake rotors and performance brake pads
- Performance suspension (FE3)
- Performance exhaust
- Performance final drive ratio
- Electronic Limited-Slip Differential
- Rear spoiler and front splitter
- Michelin® Pilot® Sport 4S summer-only tires¹
- Heavy-duty cooling system

Z51 Performance Package cars can also be ordered with a newly engineered real-time Magnetic Selective Ride Control system that includes Performance Traction Management.



¹ Do not use summer-only tires in winter conditions, as it would adversely affect vehicle safety, performance and durability. Use only GM-approved tire and wheel combinations. Unapproved combinations may change the vehicle's performance characteristics. For important tire and wheel information, go to my.chevrolet.com/learnAbout/chevrolettires or see your dealer.



DELIVERS WHAT
YOU WANT,
WHEN YOU WANT IT.

3LT INTERIOR WITH OPTIONS | SKY COOL GRAY

Corvette engineers recognize that you have different information needs in different driving situations. A 12-inch diagonal customizable gauge cluster dominates the controls with graphics that change completely depending on your selected driving mode. You can view the wide cluster display neatly framed by the racing-style steering wheel. The display itself has two panels on each side of the tachometer that you can populate with specific information or gauges

using the Options menu. An 8-inch diagonal color touch-screen is conveniently positioned just right of the central cluster.

A push-button gear selector helps simplify the console area. The Driver Mode Selector features a leather-wrapped palm rest, while climate controls are now located atop the buttress separating driver and passenger.

TECHNOLOGY



3LT INTERIOR WITH OPTIONS | NATURAL-DIPPED



GEAR AND DRIVER MODE SELECTORS



CLIMATE AND SEAT CONTROLS ATOP COCKPIT BUTTRESS

TECHNOLOGY



8-INCH DIAGONAL COLOR TOUCH-SCREEN



AVAILABLE BOSE PERFORMANCE SERIES 14-SPEAKER SYSTEM

BOUNDLESS TECHNOLOGY.

High performance takes on many dimensions in the new Stingray. Among them is the available 14-speaker Bose Performance Series, the most powerful sound system ever in a Stingray. Plus, an available 4G LTE Wi-Fi® Hotspot¹ allows you to stay connected, as does standard Apple CarPlay² and Android Auto³ compatibility.

Help yourself become a better driver with the available Performance Data Recorder. When activated, it logs video of your drive onto an SD memory card. Three modes allow you to capture video, audio driving stats, date and time, and much more. A fourth, Valet Mode, can record the activity of your car when you're not around. On the Corvette website, you can also download software developed by the same engineering firm that supplies Corvette Racing. It acts like a virtual driving coach, giving you vital metrics and comparisons.

An available Head-Up Display (HUD) system offers three distinct views for Tour, Sport and Track modes. Tour mode includes speed limit and turn-by-turn navigation prompts. Sport mode includes digital speed, tachometer and a g-force indicator. Track mode includes digital speed, tachometer, shift lights, best lap time, current lap time and gain/loss.

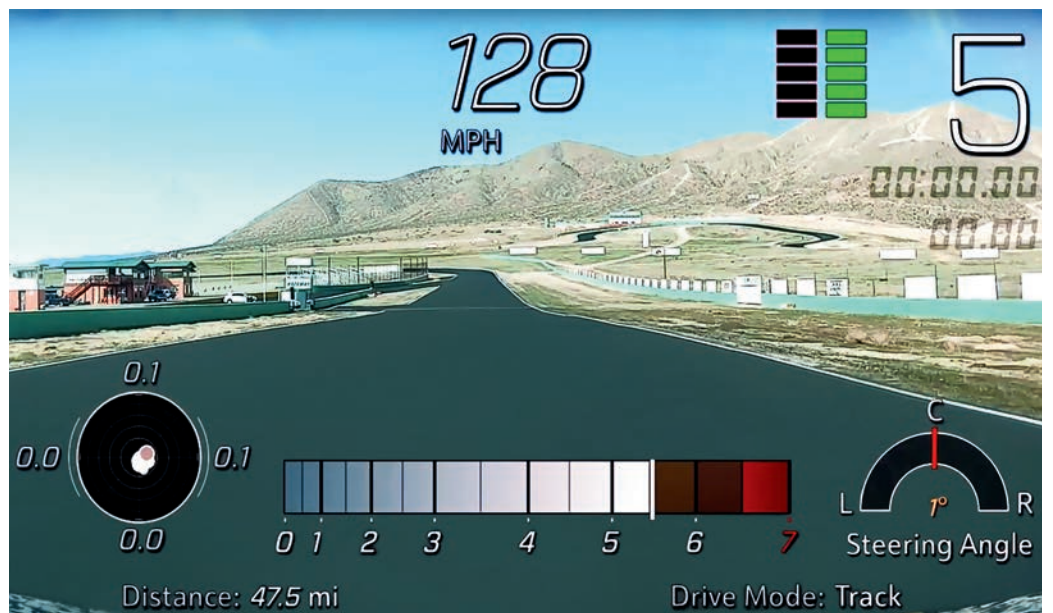
WIRELESS CHARGING⁴

PERFORMANCE DATA RECORDER

¹ Service varies with conditions and location. Requires active service and paid AT&T data plan. Visit onstar.com for details and limitations. ² Vehicle user interface is a product of Apple and its terms and privacy statements apply. Requires compatible iPhone and data plan rates apply. ³ Vehicle user interface is a product of Google and its terms and privacy statements apply. Requires the Android Auto app on Google Play and an Android compatible smartphone running Android 5.0 or higher. Data plan rates apply. ⁴ The system wirelessly charges one compatible mobile device. Some phones have built-in wireless charging technology and others require a special adaptor/back cover. To check for phone or other device compatibility, see my.chevrolet.com/learn or consult your carrier.

SEATING

COMPETITION SPORT | EXTRA
SUPPORT FOR TRACK DRIVING

GT1 | OPTIMIZED FOR COMFORT AND SUPPORT

GT2 | NAPA LEATHER FOR ULTIMATE COMFORT

THREE WAYS TO BECOME ONE WITH YOUR CORVETTE.

Becoming one with a car means you're properly situated behind the controls. Corvette offers three different seats for different driver preferences, all in a multitude of color combinations and contrasting color seat belts – and all with available thick contrasting stitching.

The GT1 seat in Mulan leather provides an intelligent balance between excellent support for enthusiastic driving and easier entry/egress for regular driving use.

The available GT2 seat in Napa leather blends the comfort of the GT1 seat with the appearance and carbon-fiber trim of the Competition Sport seat. Suede or two-tone leather inserts are available.

The available Competition Sport seat provides aggressive bolsters for track driving, with a performance textile in high-wear areas.

CARGO SPACE



FRONT TRUNK



REAR TRUNK

The new Stingray is equipped with two trunks, one in the front and one in the rear behind the engine, for luggage, coolers, groceries and more. Both coupe and convertible offer the same 12.6 cubic feet of cargo area! The front trunk will accommodate a standard carry-on roller bag as well as a medium backpack. The rear trunk will carry up to two sets of golf clubs or the removable roof panel (coupe). This kind of versatility makes Stingray a real-world grand touring machine.

¹ Cargo and load capacity limited by weight and distribution.



—

THE REWARDS OF A HIGHER EDUCATION.

—

RON FELLOWS PERFORMANCE DRIVING SCHOOL.

The premier driving academy of Corvette is located at Spring Mountain Motor Resort and Country Club in Pahrump, Nevada. Ron Fellows, a charter member of Corvette Racing — and a multi-time driving champion and class winner in every major long-distance sports car race — established the curriculum here in October 2008. The school, available to 2020 Stingray owners¹, will help you benefit from Fellows' precision-detailed regimen designed to help you fully enjoy and appreciate the capabilities of your Stingray. Learn more at corvetteownersschool.com.



—

THE CONSUMMATE DELIVERY EXPERIENCE.

Take delivery of your Stingray in thoroughbred country, right from the floor of the National Corvette Museum in Bowling Green, Kentucky. Just specify Corvette Museum Delivery when ordering your Corvette. You'll also receive a one-year individual membership to the Museum and a personalized interior plaque with your name and VIN.



—

PERSONALIZED INTERIOR PLAQUE.

Your eighth-generation Stingray is a sure collector's item. Make it even more special with an available Personalized Interior Plaque that features your name, your VIN and the Corvette crossed-flags logo.

¹ Only first retail purchasers of new and unused Corvette models are eligible. Does not include travel costs.

COLORS



ARCTIC WHITE



CERAMIC MATRIX GRAY METALLIC



BLADE SILVER METALLIC



SHADOW GRAY METALLIC



ZEUS BRONZE METALLIC



ACCELERATE YELLOW METALLIC¹



TORCH RED



LONG BEACH RED METALLIC TINTCOAT¹



SEBRING ORANGE TINTCOAT¹



RAPID BLUE¹



ELKHART LAKE BLUE METALLIC



BLACK

¹Extra-cost color.

WHEELS



19" X 8.5" FRONT AND 20" X 11" REAR
5-OPEN-SPOKE
BRIGHT SILVER-PAINTED ALUMINUM WHEELS



19" X 8.5" FRONT AND 20" X 11" REAR
5-OPEN-SPOKE
CARBON FLASH METALLIC-PAINTED
ALUMINUM WHEELS WITH MACHINED EDGE



19" X 8.5" FRONT AND 20" X 11" REAR
5-TRIDENT-SPOKE
BLACK-PAINTED ALUMINUM WHEELS
FROM CORVETTE ACCESSORIES¹



19" X 8.5" FRONT AND 20" X 11" REAR
5-TRIDENT-SPOKE
MACHINED-FACE STERLING SILVER-
PAINTED ALUMINUM WHEELS



19" X 8.5" FRONT AND 20" X 11" REAR
5-TRIDENT-SPOKE
MACHINED-FACE SPECTRA GRAY-PAINTED
ALUMINUM WHEELS



19" X 8.5" FRONT AND 20" X 11" REAR
5-OPEN-SPOKE
PERFORMANCE PEWTER-PAINTED ALUMINUM
WHEELS FROM CORVETTE ACCESSORIES¹

CALIPER COLORS



STANDARD BLACK-PAINTED
BREMBO® BRAKE CALIPERS



AVAILABLE BRIGHT RED-PAINTED
BREMBO BRAKE CALIPERS



AVAILABLE EDGE RED-PAINTED
BREMBO BRAKE CALIPERS



AVAILABLE YELLOW-PAINTED
BREMBO BRAKE CALIPERS

¹ Corvette Accessories are dealer-installed and covered by the GM 3-year/36,000-mile (whichever comes first) New Vehicle Limited Warranty when ordered with your new Corvette. See your dealer for details.

SEAT BELT COLORS



BLACK / ORANGE / NATURAL / TENSION BLUE / TORCH RED / YELLOW

INTERIOR COLORS

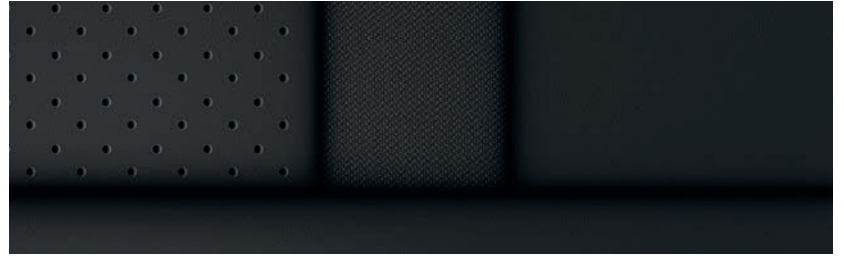

JET BLACK

1LT/2LT MULAN LEATHER | PERFORATED INSERTS
1LT PERFORMANCE TEXTILE¹
2LT/3LT NAPA LEATHER | PERFORATED INSERTS
2LT/3LT NAPA LEATHER | PERFORATED SUEDED MICROFIBER INSERTS¹

SEATS GT1 / GT2 / COMPETITION SPORT

SEAT BELT COLORS



INTERIOR CONFIGURATIONS | SELECT EXAMPLES AND OPTIONS SHOWN



JET BLACK INTERIOR² | 3LT | NAPA LEATHER | COMPETITION SPORT SEATS | ADRENALINE RED CUSTOM STITCHING | RED SEAT BELTS



JET BLACK INTERIOR² | 3LT | NAPA LEATHER | SUEDED MICROFIBER INSERTS¹ | COMPETITION SPORT SEATS | YELLOW CUSTOM STITCHING | YELLOW SEAT BELTS

¹ Requires available sueded microfiber-wrapped steering wheel. ² Also features available carbon-fiber cluster surround and console/door switch plates.

INTERIOR COLORS

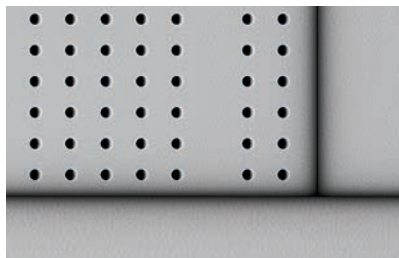

SKY COOL GRAY



TWO-TONE SKY COOL GRAY¹

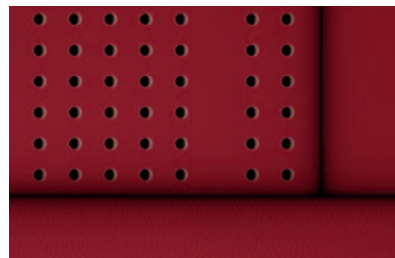

ADRENALINE RED

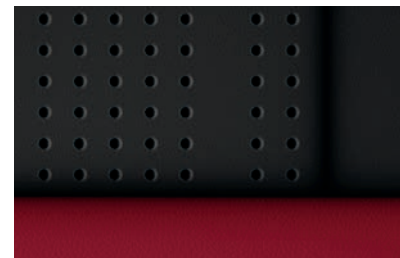

TWO-TONE ADRENALINE RED³

1LT/2LT MULAN LEATHER | PERFORATED INSERTS
2LT/3LT NAPA LEATHER | PERFORATED INSERTS
2LT/3LT NAPA LEATHER | PERFORATED SUEDED MICROFIBER INSERTS²

1LT/2LT MULAN LEATHER | PERFORATED INSERTS
2LT/3LT NAPA LEATHER | PERFORATED INSERTS
2LT/3LT NAPA LEATHER | PERFORATED SUEDED MICROFIBER INSERTS²

SEATS GT1 / GT2 / COMPETITION SPORT

SEATS GT1 / GT2 / COMPETITION SPORT

SEAT BELT COLORS



SEAT BELT COLORS



SKY COOL GRAY INTERIOR | 2LT | MULAN LEATHER | GT1 SEATS | BLACK SEAT BELTS



ADRENALINE RED INTERIOR | 2LT | MULAN LEATHER | GT1 SEATS | TORCH RED SEAT BELTS

¹ Requires GT2 seats. Seats are Jet Black when ordered with Competition Sport seats. ² Requires available sueded microfiber-wrapped steering wheel. ³ Requires GT2 seats.

INTERIOR COLORS

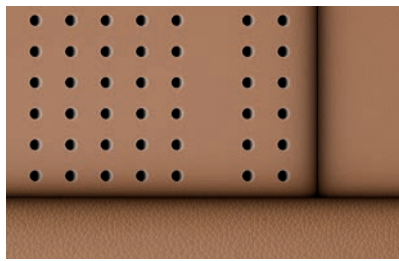

NATURAL

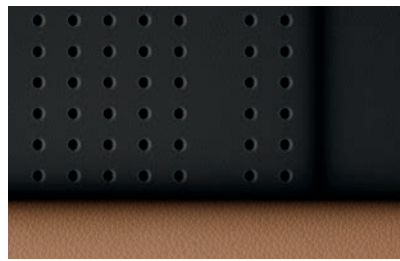

TWO-TONE NATURAL¹

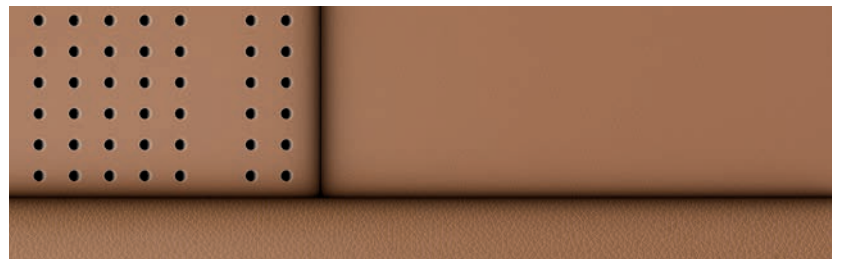

NATURAL-DIPPED³

2LT MULAN LEATHER | PERFORATED INSERTS
2LT/3LT NAPA LEATHER | PERFORATED INSERTS
2LT/3LT NAPA LEATHER | PERFORATED SUEDED MICROFIBER INSERTS²

3LT NAPA LEATHER | PERFORATED INSERTS
3LT NAPA LEATHER | PERFORATED SUEDED MICROFIBER INSERTS²

SEATS GT1 / GT2 / COMPETITION SPORT

SEATS GT2 / COMPETITION SPORT

SEAT BELT COLORS



SEAT BELT COLORS



NATURAL INTERIOR | 2LT | MULAN LEATHER | GT1 SEATS | BLACK SEAT BELTS



NATURAL-DIPPED³ INTERIOR⁴ | 3LT | NAPA LEATHER | GT2 SEATS | NATURAL SEAT BELTS

¹ Requires GT2 seats. ² Requires available sueded microfiber-wrapped steering wheel. ³ Full-color interior includes instrument panel, doors and carpet. This interior features light color throughout and may require extra care to avoid soiling. Certain lighting conditions may cause a noticeable reflection on the inside of the windshield. ⁴ Also features available carbon-fiber cluster surround and console/door switch plates.

INTERIOR COLORS

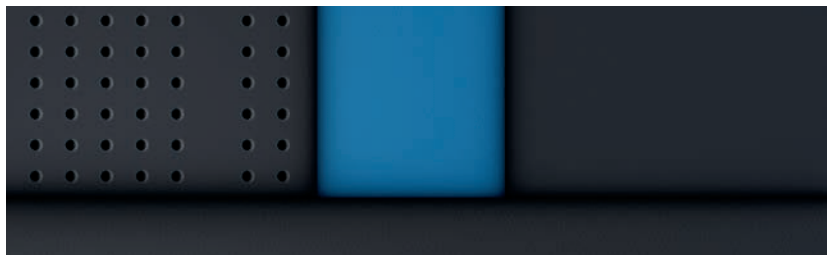

TENSION BLUE/TWILIGHT BLUE-DIPPED¹

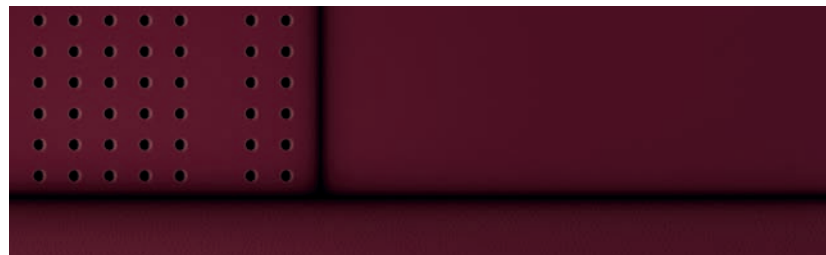

MORELLO RED-DIPPED¹

3LT NAPA LEATHER | PERFORATED INSERTS

3LT NAPA LEATHER | PERFORATED INSERTS

SEATS GT2 / COMPETITION SPORT

SEATS GT2 / COMPETITION SPORT

SEAT BELT COLOR



SEAT BELT COLORS



TENSION BLUE/TWILIGHT BLUE-DIPPED¹ INTERIOR² | 3LT | NAPA LEATHER | GT2 SEATS | TENSION BLUE SEAT BELTS



MORELLO RED-DIPPED¹ INTERIOR² | 3LT | NAPA LEATHER | GT2 SEATS | BLACK SEAT BELTS

¹ Full-color interior includes instrument panel, doors and carpet. ² Also features available carbon-fiber cluster surround and console/door switch plates.

ACCESSORIES



2-PIECE PREMIUM LEATHER TRAVEL BAGS IN JET BLACK WITH CROSSED-FLAGS LOGO



PREMIUM LEATHER TRAVEL BAG IN JET BLACK WITH CROSSED-FLAGS LOGO



PREMIUM INDOOR CAR COVER IN BLACK WITH EMBOSSED CROSSED-FLAGS LOGO



PREMIUM INDOOR CAR COVER IN RED WITH EMBOSSED STINGRAY LOGO



PREMIUM OUTDOOR CAR COVER IN BLACK WITH STINGRAY LOGO



PREMIUM CARPETED FLOOR MATS IN JET BLACK WITH TORCH RED STITCHING (ALSO AVAILABLE WITH BLACK, GRAY OR NATURAL STITCHING)



DOORSILL PLATES WITH ILLUMINATED STINGRAY LOGO

ACCESSORIES



HIGH WING SPOILER IN CARBON FLASH METALLIC (ALSO AVAILABLE IN BLACK, TORCH RED, SHADOW GRAY METALLIC AND ARCTIC WHITE)



FENDER HASH MARKS IN MIDNIGHT SILVER AND CARBON FLASH METALLIC ACCENTS



FENDER HASH MARKS IN EDGE RED AND CARBON FLASH METALLIC ACCENTS



FENDER HASH MARKS IN CARBON FLASH METALLIC AND EDGE RED ACCENTS



CORVETTE SCRIPT REAR EMBLEM IN TORCH RED (ALSO AVAILABLE IN ARCTIC WHITE AND ELKHART LAKE BLUE METALLIC)



MIRROR CAPS IN VISIBLE CARBON FIBER



SIDE ROCKER EXTENSIONS IN BLACK



GRILLE INSERTS IN VISIBLE CARBON FIBER



FRONT SPLASH GUARDS IN BLACK

STANDARD AND AVAILABLE FEATURES

● STANDARD ○ AVAILABLE – NOT AVAILABLE	1LT	2LT	3LT
ENGINE/CHASSIS			
Engine: 6.2L LT2 V8 with Direct Injection, Variable Valve Timing and Active Fuel Management	●	●	●
Transmission: 8-speed dual-clutch with manual and automatic modes	●	●	●
Performance final drive ratio (included and only available with Z51 Performance Package)	○	○	○
Differential: Electronic Limited-Slip (eLSD) (included and only available with Z51 Performance Package)	○	○	○
Exhaust: Performance (increase of 5 horsepower and 5 lb.-ft. of torque), stainless steel tips, aggressive exhaust sound varies with driver mode selection	○	○	○
Suspension: 4-wheel independent	●	●	●
Z51 Performance (FE3) (included and only available with Z51 Performance Package)	○	○	○
Z51 Performance (FE4) with Magnetic Selective Ride Control, includes Performance Traction Management (requires available Z51 Performance Package)	○	○	○
Brakes: 4-wheel antilock, 4-wheel disc, 4-piston calipers (12.6-inch front rotors, 13.3-inch rear rotors)	●	●	●
Z51 Performance (13.6-inch front rotors, 13.8-inch rear rotors) with Z51 logo on calipers (included and only available with Z51 Performance Package)	○	○	○
Painted brake calipers: Black	●	●	●
Bright Red	○	○	○
Edge Red	○	○	○
Yellow	○	○	○
Cooling system: Heavy-duty (included and only available with Z51 Performance Package)	○	○	○
EXTERIOR			
Accents: Body-color side vents and front/rear grille accents; body-color tonneau grille accents (convertible)	○ ¹	○ ¹	○ ¹
Shadow Gray side vents and front/rear grille accents; Shadow Gray tonneau grille accents (convertible)	○	○	○
Convertible top: Carbon Flash Metallic-painted nacelles and roof	○ ¹	○ ¹	○ ¹
Carbon Flash Metallic-painted nacelles and body-color roof	○ ¹	○ ¹	○ ¹
Front lift: Adjustable height with memory	–	○	○
Mirrors: Carbon Flash Metallic-painted (includes Carbon Flash Metallic-painted spoiler when ordered with Z51 Performance Package)	○	○	○
GRAPHICS			
Carbon Flash Metallic full-length dual racing stripe	○	○	○
Midnight Gray full-length dual racing stripe	○	○	○
Sterling Silver full-length dual racing stripe	○	○	○
COUPE REMOVABLE ROOF PANEL OPTIONS			
One-piece transparent roof panel	○	○	○
One-piece visible carbon-fiber roof panel with body-color surround	○	○	○
Body-Color Dual Roof Package: Body-color roof panel, transparent roof panel and Roof Panel Storage Pouch from Corvette Accessories ²	○	○	○
Carbon-Fiber Dual Roof Package: Transparent roof panel, visible carbon-fiber roof panel with body-color surround and Roof Panel Storage Pouch from Corvette Accessories ²	○	○	○
WHEELS			
19" x 8.5" front and 20" x 11" rear 5-open-spoke wheels in Bright Silver-painted aluminum	●	●	●
19" x 8.5" front and 20" x 11" rear 5-open-spoke wheels in Carbon Flash Metallic-painted aluminum with machined edge	○	○	○
19" x 8.5" front and 20" x 11" rear 5-trident-spoke machined-face wheels in Sterling Silver-painted aluminum	○	○	○
19" x 8.5" front and 20" x 11" rear 5-trident-spoke machined-face wheels in Spectra Gray-painted aluminum	○	○	○
SAFETY & SECURITY			
Airbags: ³ Driver and passenger frontal and side-impact with Passenger Sensing System	●	●	●
Rear Camera Mirror: ⁴ Rearview auto-dimming with full camera display (coupe)	–	●	●
Rearview auto-dimming with full camera display (convertible)	●	●	●
Rear Cross Traffic Alert ⁴	–	●	●
Rear Park Assist ⁴	●	●	●
Side Blind Zone Alert ⁴	–	●	●
Teen Driver technology	●	●	●
Theft-deterrent system: Engine immobilizer and audible/visual alarm	●	●	●
Electrical, unauthorized entry, vehicle inclination sensor, vehicle interior movement sensor; activates horn	–	●	●

1 Not available with Black exterior color. **2** Corvette Accessories are dealer-installed and covered by the GM 3-year/36,000-mile (whichever comes first) New Vehicle Limited Warranty when ordered with your new Corvette. See your dealer for details. **3** A NOTE ON CHILD SAFETY: Always use seat belts and the correct child restraint for your child's age and size, even with airbags. Even in vehicles equipped with the Passenger Sensing System, children are safer when properly secured in a rear seat in the appropriate infant, child or booster seat. Never place a rear-facing infant restraint in the front seat of any vehicle equipped with an active frontal airbag. See your vehicle Owner's Manual and the child safety seat instructions for more safety information. **4** Read the vehicle Owner's Manual for important feature limitations and information. **5** Natural-Dipped interior comes with Natural seat belts. Tension Blue/Twilight Blue-Dipped interior color comes with Tension Blue seat belts. **6** Not available with Adrenaline Red interior color. **7** Not available with Adrenaline Red, Morello Red-Dipped or Tension Blue/Twilight Blue-Dipped interior colors. **8** Requires Jet Black interior color. **9** Requires Jet Black or Natural interior color. **10** Requires Jet Black or Natural interior color. Included with Natural-Dipped interior color. **11** Not available with Adrenaline Red or Morello Red-Dipped interior colors. Included with Tension Blue/Twilight Blue-Dipped interior color. **12** Not available with Tension Blue/Twilight Blue-Dipped interior color. **13** Requires sueded microfiber-wrapped steering wheel. **14** Requires GT2 bucket seats. Available with Sky Cool Gray, Adrenaline Red or Natural interior colors. **15** Requires GT2 bucket seats. Available with Sky Cool Gray, Adrenaline Red, Natural, Jet Black/Sky Cool Gray or Jet Black/Adrenaline Red interior colors. **16** Requires Napa leather seating surfaces with perforated sueded microfiber inserts. **17** Requires Jet Black or Adrenaline Red/Jet Black interior color. **18** Chevrolet Infotainment System functionality varies by model. Full functionality requires compatible Bluetooth and smartphone, and USB connectivity for some devices. Map coverage available in the United States, Puerto Rico and Canada. **19** Go to my.chevrolet.com/learnAbout/bluetooth to find out which phones are compatible with the vehicle. Full Bluetooth feature functionality varies by device, model and software version. **20** Vehicle user interface is a product of Apple and its terms and privacy statements apply. Requires compatible iPhone and data plan rates apply. **21** Vehicle user interface is a product of Google and its terms and privacy statements apply. Requires the Android Auto app on Google Play and an Android compatible smartphone running Android 5.0 or higher. Data plan rates apply. **22** Requires active service plan and paid AT&T vehicle data plan or compatible device with 3G/4G LTE tethering data plan. Visit onstar.com for details and limitations. **23** Connected Navigation and Real-time Points of Interest (POI) only available on properly equipped vehicles. Requires paid plan or trial. Map coverage available in the United States, Puerto Rico and Canada. Visit onstar.com for details and limitations. **24** Requires available Chevrolet Infotainment 3 Premium system with Navigation. **25** Certain features require a SiriusXM subscription and the Chevrolet Connected Access plan. See siriusxm.com and onstar.com for details and limitations. **26** Service varies with conditions and location. Requires active service and paid AT&T data plan. Visit onstar.com for details and limitations. **27** Standard connectivity available only to original purchaser for 10 years. Services enabled by Connected Access are subject to change. Does not include emergency or security services. Diagnostic capabilities vary by model and service plan. Message and data rates may apply. Requires contact method on file and enrollment to receive alerts. Not all issues will deliver alerts. Visit onstar.com for details and limitations. **28** Do not use summer-only tires in winter conditions, as it would adversely affect vehicle safety, performance and durability. Use only GM-approved tire and wheel combinations. Unapproved combinations may change the vehicle's performance characteristics. For important tire and wheel information, go to my.chevrolet.com/learnAbout/chevrolettires or see your dealer.

	1LT	2LT	3LT
INTERIOR			
Corvette Museum Delivery: Corvette Museum logo plaque personalized with your name and VIN (acknowledgment form required)	○	○	○
Custom-made interior plaque personalized with your name and VIN	○	○	○
Seat belts: Black	●	●	● ⁵
Orange	○ ⁶	○ ⁶	○ ⁷
Natural	○ ⁸	○ ⁹	○ ¹⁰
Tension Blue	○ ⁶	○ ⁶	○ ¹¹
Torch Red	○	○	○ ¹²
Yellow	○ ⁶	○ ⁶	○ ⁷
GT1 bucket seats	●	●	–
– Mulan leather seating surfaces with perforated inserts	●	●	–
GT2 bucket seats	–	○	●
– Napa leather seating surfaces with perforated inserts	–	○	●
– Napa leather seating surfaces with perforated sueded microfiber inserts	–	○ ¹³	●
– Two-tone	–	○ ¹⁴	○ ¹⁵
Competition Sport bucket seats	○	○	○
– Performance textile	○ ¹³	–	–
– Napa leather seating surfaces with perforated inserts	–	○	○
– Napa leather seating surfaces with perforated sueded microfiber inserts	–	○ ¹³	○
Steering wheel: Sueded microfiber-wrapped	○ ⁸	○ ¹⁶	○ ¹⁶
Custom interior leather stitching: Adrenaline Red stitching on seats, instrument panel, doors and console	–	–	○ ¹⁷
Yellow stitching on seats, instrument panel, doors and console	–	–	○ ⁸
Trim: Carbon-fiber cluster surround and console/door switch plates	–	○	○
ENTERTAINMENT			
Chevrolet Infotainment 3 Plus system ¹⁸ with 8-inch diagonal HD color touch-screen, AM/FM stereo, HD Radio [®] Bluetooth [®] audio streaming ¹⁹ for two active devices, Apple CarPlay ^{®20} and Android Auto ^{™21} compatibility, voice recognition and in-vehicle apps ²²	●	–	–
Chevrolet Infotainment 3 Premium system with Navigation ¹⁶ includes Plus system features listed above, Connected Navigation ²³ enhanced voice recognition, additional memory for in-vehicle apps ²² and Performance Data Recorder	○	●	●
Performance Data Recorder	○ ²⁴	●	●
SiriusXM [®] with 360L ²⁵ – All Access Package with 12-month subscription (3-month on 1LT)	●	●	●
4G LTE Wi-Fi ^{®26} Hotspot for up to seven devices, includes 1 month or 3 GB of data (whichever comes first)	○	○	○
Chevrolet Connected Access ²⁷ with 10 years of standard connectivity, which currently enables features such as Vehicle Diagnostics and Dealer Maintenance Notification	●	●	●
PACKAGES			
Z51 Performance Package	○	○	○
Z51 Performance brakes, Z51 Performance suspension (FE3), performance exhaust, performance final drive ratio, electronic Limited-Slip Differential (eLSD), Z51 rear spoiler, front splitter, 245/35ZR19 front and 305/30ZR20 rear summer-only ²⁸ high-performance tires and heavy-duty cooling system			
Battery Protection Package	○	○	○
Chrome Exterior Badge Package	○	○	○
Engine Appearance Package	○	○	○
Carbon-fiber trim and lighting (coupe)			

STATISTICS



3LT COUPE WITH Z51 PERFORMANCE PACKAGE AND OPTIONS | TORCH RED

	CORVETTE STINGRAY	CORVETTE STINGRAY WITH Z51 PERFORMANCE PACKAGE
Engine	6.2L LT2 V8	6.2L LT2 V8
Compression Ratio	11.5:1	11.5:1
Horsepower	490 hp @ 6450 rpm	495 hp @ 6450 rpm
Torque	465 lb.-ft. @ 5150 rpm	470 lb.-ft. @ 5150 rpm
Redline	6600 rpm	6600 rpm
Final Drive Ratio	4.9:1	5.2:1
0 to 60 (Based on initial vehicle movement)	3.0 seconds	2.9 seconds
Quarter-Mile	11.2 seconds @ 123 mph	11.2 seconds @ 121 mph
Skid Pad (Max lateral acceleration)	0.94 g	1.02 g
Top Track Speed	194 mph (with standard suspension)	184 mph (with FE4 Magnetic Selective Ride Control suspension)
Braking System	4-wheel antilock, 4-wheel disc, Brembo® 4-piston calipers	4-wheel antilock, 4-wheel disc, Brembo monobloc 4-piston calipers with Z51 logo
Rotor Diameter	12.6-inch (front), 13.3-inch (rear)	13.6-inch (front), 13.8-inch (rear)
Braking Distance (60 to 0 mph)	114.9 ft.	108.2 ft.
Dry Weight	3,366 lbs. (coupe) 3,467 lbs. (convertible)	
Tires	245/35ZR19 front and 305/30ZR20 rear, all-season, performance	245/35ZR19 front and 305/30ZR20 rear, high-performance, summer-only ¹
Weight Distribution (Front/rear)	40/60	40/60

¹ Do not use summer-only tires in winter conditions, as it would adversely affect vehicle safety, performance and durability. Use only GM-approved tire and wheel combinations. Unapproved combinations may change the vehicle's performance characteristics. For important tire and wheel information, go to my.chevrolet.com/learnAbout/chevrolettires or see your dealer.

SPECIFICATIONS

CORVETTE STINGRAY

Wheelbase	107.2 in./2723 mm
Overall Length	182.3 in./4630 mm
Overall Width (Without mirrors)	76.1 in./1933 mm
Track	64.9 in./1648 mm front 62.4 in./1585 mm rear
Height	48.6 in./1234 mm
Luggage Capacity¹	12.6 cu. ft./356.8 L
Steering Wheel Diameter	14.17 in./360 mm
Turning Circle: Curb to Curb	11.6 ft./3.54 m 11.1 ft./3.38 m (Z51 with FE4 suspension)
Steering Rotation: Lock to Lock	2.4 turns 2.5 turns (Z51 with FE4 suspension)
Fuel Tank (Approximate)	18.5 gal./70 L
EPA-Estimated Fuel Economy	15 MPG city/27 MPG highway/19 MPG combined
Engine	6.2L LT2 V8 with Direct Injection, Variable Valve Timing and Active Fuel Management
Horsepower	490 hp @ 6450 rpm 495 hp @ 6450 rpm (with performance exhaust or Z51 Performance Package)
Torque	465 lb.-ft. @ 5150 rpm 470 lb.-ft. @ 5150 rpm (with performance exhaust or Z51 Performance Package)
Bore and Stroke	103.25 mm x 92.00 mm
Firing Order	1-8-7-2-6-5-4-3
Fuel System	Direct Injection
Fuel	Premium recommended
Block	Cast aluminum
Cylinder Head	Cast aluminum
Intake Valves	Hollow
Exhaust Valves	Hollow sodium-filled
Intake Manifold	Composite
Exhaust Manifold	Cast nodular steel
Main Bearing Caps	Cast nodular steel
Crankshaft	Forged steel
Camshaft	Billet steel
Connecting Rods	Forged powder metal
Additional Engine Features	Integrated composite dry-sump oiling system with 7.5-quart tank Rear-facing 87 mm throttle body includes identical 210 mm intake runners 3 oil scavenge pumps

Transmission

Transmission Ratios
(:1)

1	2.91
2	1.76
3	1.22
4	0.88
5	0.65
6	0.51
7	0.40
8	0.33
Final Drive	4.9:1 5.2:1 (with Z51 Performance Package)

¹ Cargo and load capacity limited by weight and distribution.

Experience Chevrolet Complete Care, a comprehensive coverage, warranty and protection program that comes standard with every new 2020 Chevrolet Corvette lease and purchase. Simply, it is designed around you, to make it easy to keep your Chevrolet like new – and give you the confidence you deserve when you need it most.

Your comprehensive owner benefit program.

Includes one maintenance visit (oil change, transmission filter change and multi-point vehicle inspection).¹

5 years/60,000 miles² of Roadside Assistance³ and Courtesy Transportation.

3-year/36,000-mile² Bumper-to-Bumper Limited Warranty.

5-year/60,000-mile² Powertrain Limited Warranty.

6 years/100,000 miles² of Rust-Through Protection.

Chevrolet Connected Access⁴ with 10 years of standard connectivity, which currently enables features such as Vehicle Diagnostics and Dealer Maintenance Notification.

1 month of Chevrolet Connected Services⁵ and 1 month of OnStar Safety & Security Plan coverage.⁵



CHEVROLET

COMPLETE CARE

NEW VEHICLE LIMITED WARRANTY

3-year/36,000-mile Bumper-to-Bumper Limited Warranty.

Chevrolet will warrant each 2020 Corvette from bumper to bumper for 3 years/36,000 miles (whichever comes first; see dealer for details), with no deductible, from the original in-service date of the vehicle, for warrantable repairs that are required as a result of defects due to materials and/or workmanship. Cosmetic corrosion resulting from defects is also covered under the Bumper-to-Bumper Limited Warranty. In addition, rust-through corrosion will be covered for 6 years/100,000 miles (whichever comes first). See dealer for details.

5-year/60,000-mile transferable Powertrain Limited

Warranty. Every 2020 Corvette comes with a 5-year/60,000-mile (whichever comes first) transferable Powertrain Limited Warranty. 24/7 Roadside Assistance and Courtesy Transportation are also offered for the duration of the Powertrain Limited Warranty. Please see your Chevrolet dealer for details.

IMPORTANT INFORMATION

Chevrolet Owner Center (my.chevrolet.com). Everything you need to know. Anything you need to do. Your Chevrolet Owner Center makes it easy. Create your account today to get the most out of your new vehicle. Get special alerts and offers, schedule service, review your maintenance schedule, and view how-to videos specifically for your vehicle. All online, anytime. Visit the Owner Center today to register or take a tour.

Engines. Chevrolet products are equipped with engines produced by GM Global Propulsion Systems or other suppliers to GM worldwide. The engines in Chevrolet products may also be used in other GM makes and models.

Assembly. Chevrolet vehicles and their components are assembled or produced by different operating units of General Motors, its subsidiaries or suppliers to GM worldwide. We sometimes find it necessary to produce Chevrolet vehicles with different or differently sourced components than originally scheduled. Since some options may be unavailable when your vehicle is assembled, we suggest you verify that your vehicle includes the equipment you ordered and that, if there were changes, they are acceptable to you.

Chevrolet Connected Services and OnStar. Connected vehicle services vary by vehicle model and require an active service plan, working vehicle electrical system (including battery), cell reception and GPS signal to function properly. Visit onstar.com for details and limitations.

A note on child safety. Always use seat belts and the correct child restraint for your child's age and size, even with airbags. Even in vehicles equipped with the Passenger Sensing System, children are safer when properly secured in a rear seat in the appropriate infant, child or booster seat. Never place a rear-facing infant restraint in the front seat of any vehicle equipped with an active frontal airbag. See your vehicle Owner's Manual and the child safety seat instructions for more safety information.

Important words about this catalog. We have tried to make this catalog comprehensive and factual. We reserve the right, however, to make changes at any time, without notice, in prices, colors, materials, equipment, specifications, models and availability. Specifications, dimensions, measurements, ratings and other numbers in this catalog and other printed materials provided at the dealership or affixed to vehicles are approximations based on design and engineering drawings, prototypes and laboratory tests. Your vehicle may differ due to variations in manufacture and equipment. Since some information may have been updated since the time of printing, please check with your Chevrolet dealer for complete details. Chevrolet reserves the right to lengthen or

shorten the model year for any product for any reason or to start and end model years at different times. Certain vehicle features may lose their usefulness over time due to obsolescence from technological changes. Unless otherwise noted, all claims based on GM Luxury Sports Car segment and latest available competitive information. Excludes other GM vehicles.

Tires. Corvette is equipped with run-flat Michelin® Pilot® tires that eliminate the need for a spare. The tire design enables safe function during and after loss of pressure for some distance at a moderate speed. The shorter the distance that you drive with loss of pressure, the better the chance that the tire can be repaired. As soon as possible, contact Roadside Assistance for the nearest authorized GM or run-flat tire servicing facility and have the tire inspected. See your Owner's Manual. Corvette has low-profile tires that tend to wear faster and are more susceptible to damage from road hazards or curb impact than standard profile tires. This type of damage is not covered by the GM New Vehicle Limited Warranty.

Fleet orders. Some standard content may be deleted on fleet orders. See dealer for details.

Chevrolet ownership experience. Chevrolet is committed to enhancing the vehicle shopping and ownership experience through a wide array of programs. Visit chevrolet.com to build and price, find a vehicle, request a quote, compare vehicles, find financial tools or track your vehicle order. You'll also find information about 24-hour Roadside Assistance, Courtesy Transportation, Customer Assistance, GM Mobility, safety and current incentives.

Chevrolet.com/safety. Chevrolet is committed to keeping you and your family safe – from the start of your journey to your destination. That's why every Chevrolet is designed with a comprehensive list of safety and security features to help give you peace of mind.

GMmobility.com (1-800-323-9935). GM Mobility™ offers financial assistance for eligible adaptive equipment to make automotive travel easier for persons with disabilities or special transportation needs. To learn more about special GM Mobility offers, visit gmmobility.com.

The BuyPower Card. The Chevrolet BuyPower Card – Every purchase you make with the BuyPower Card from Capital One* helps you earn toward an eligible new Chevrolet, Buick, GMC or Cadillac vehicle. There's no limit on the amount you can earn or redeem, and your Earnings don't expire. Visit chevroletbuypowercard.com/catalogs.

* Capital One, N.A. is the issuer of the BuyPower Card. General Motors ("GM") is responsible for the operation and administration of the Earnings program.



GM, the GM logo, Chevrolet, the Chevrolet logo, and the slogans, emblems, vehicle model names, vehicle body designs and other marks appearing in this catalog are the trademarks and/or service marks of General Motors, its subsidiaries, affiliates or licensors. ©2020 OnStar LLC. All rights reserved. Sirius, XM, SiriusXM and all related marks and logos are trademarks of Sirius XM Radio Inc. Bose is a trademark of the Bose Corp. The Bluetooth word mark is a registered trademark owned by Bluetooth SIG, Inc., and any use of such mark by Chevrolet is under license. Brembo is a registered trademark of Brembo S.p.A. Michelin and Pilot are registered trademarks of Michelin North America, Inc.

©2020 General Motors. All rights reserved. April 2020

¹ Maintenance visit must occur within first year of vehicle delivery. Service visit consists of Mobil 1™ Oil and Filter Change and MPVI. Does not include air filters. See participating dealer for other restrictions and complete details.

² Whichever comes first. See dealer for details. ³ Roadside service provided by Allstate Roadside Services. Limitations apply. ⁴ Standard connectivity available only to original purchaser for 10 years. Services enabled by Connected Access are subject to change. Does not include emergency or security services. Diagnostic capabilities vary by model and service plan. Message and data rates may apply. Requires contact method on file and enrollment to receive alerts. Not all issues will deliver alerts. Visit onstar.com for details and limitations. ⁵ Connected services include navigation services and Remote Access Plan. Services subject to terms and limitations. Certain services require working electrical system, cell reception and GPS signal. OnStar links to emergency services. Visit onstar.com for details. Availability subject to change.



“ ALL CORVETTES
ARE PERFORMANCE
CARS.
THE DIFFERENCE
IS DEGREE. ”

— ZORA ARKUS-DUNTOV



Racing has always played a vital role in the development of the production Corvette. The technical transfer between racing and production goes back to the early years of Corvette under Zora Arkus-Duntov. The current Corvette Racing program began in 1999, and the team has won its class at Le Mans eight times since.

A new chapter begins with Zora's mid-engine dream now a reality as the C8.R takes on the world at venues like Le Mans, Sebring and Daytona. Its new war cry signals that the spirit of Zora is alive and well in all things Corvette.

FIND NEW ROADS™

CHEVROLET 

