

CHEVROLET 



2022
TRAILBLAZER

Find your path.

We're adventure seekers, always looking to discover what's beyond our front door. The 2022 Trailblazer can help lead the way.

Available in FWD or AWD, this small SUV has the capability to carry you on an urban excursion or off to the back roads. Because getting there is half the fun, Trailblazer comes with style to spare, including rugged looks and a flexible, functional interior for all your gear. Plus, Chevy Safety Assist¹ is standard and includes six advanced driver assistance features. There's a big world out there. See it all in the Chevy Trailblazer.



Trailblazer ACTIV in Zeus Bronze Metallic with Summit White roof and available features.

¹ Chevy Safety Assist includes Automatic Emergency Braking, Front Pedestrian Braking, Lane Keep Assist with Lane Departure Warning, Forward Collision Alert, IntelliBeam and Following Distance Indicator. Safety or driver assistance features are no substitute for the driver's responsibility to operate the vehicle in a safe manner. Read the vehicle Owner's Manual for important feature limitations and information.

INTRODUCING TRAILBLAZER

Trailblazer at a glance.

- All models available as FWD or AWD
- Three driver modes¹
- ACTIV developed and tuned for off-road use
- Chevy Safety Assist², standard on all models, includes
 - Automatic Emergency Braking
 - Front Pedestrian Braking
 - Lane Keep Assist with Lane Departure Warning
 - Forward Collision Alert
 - IntelliBeam[®]
 - Following Distance Indicator
- Seating for up to five
- A generous 39.4 inches of rear-seat leg room
- Up to 54.4 cubic feet of maximum cargo space³ with the rear seats folded flat
- Maximum cargo length is 8.5 feet with the front passenger seat and rear seats folded flat – so you can fit longer items like kayaks or ladders
- The flexible cargo area features a reversible two-tier floor, with one side carpeted and the other side a durable surface for easy cleaning



Available Driver Mode Selector.



Trailblazer ACTIV interior in Jet Black with Almond Butter accents and available features.

¹ With available ECOTEC 1.3L Turbo engine. ² Safety or driver assistance features are no substitute for the driver's responsibility to operate the vehicle in a safe manner. Read the vehicle Owner's Manual for important feature limitations and information.

³ Cargo and load capacity limited by weight and distribution.

MODELS

Four models to choose from.

With all these choices, there's going to be a Trailblazer that fits every personality.



LS

With style and substance that goes on for miles, LS is anything but basic.

- ECOTEC® 1.2L Turbo engine (FWD models)
- ECOTEC 1.3L Turbo engine with Driver Mode Selector (AWD models)
- 17-inch Silver-painted aluminum wheels
- Choice of Medium Ash Gray or Jet Black cloth interior
- Wireless Apple CarPlay®¹ compatibility
- Wireless Android Auto™² compatibility
- Chevrolet Infotainment 3 system³ with 7-inch diagonal color touch-screen
- 6-speaker audio system
- Single-zone automatic air conditioning



LT

Comfort and convenience take a step forward in LT.

- Silver-painted front and rear fascias and roof rails
- LED fog lamps
- 17-inch high-gloss Black machined-aluminum wheels
- Deep-tinted rear windows and liftgate glass
- Heated power-adjustable mirrors with body-color caps
- Remote vehicle starter system
- Keyless Open and Start
- Electronic cruise control
- 8-way power driver seat with 2-way power lumbar control
- Available leatherette seating surfaces⁴



ACTIV

What's in a name? When it's Trailblazer ACTIV – everything.

- ECOTEC 1.3L Turbo engine
- Special shocks and sport terrain tires
- Functional skid plate
- 17-inch high-gloss Black machined-aluminum wheels
- Contrasting roof color⁵ and Black roof rails
- Dual-outlet exhaust with trapezoidal polished tips
- Heated power-adjustable mirrors with roof-color caps
- Titanium chrome-plated front and rear fascias and bold side cladding
- Leatherette seating surfaces
- Leather-wrapped steering wheel and leather-wrapped shift knob



RS

There's an adventure down every avenue in Trailblazer RS.

- Camaro-inspired front grille
- 18-inch high-gloss Black machined-aluminum wheels
- Contrasting roof color⁵ and Black roof rails
- Dual-outlet exhaust with round polished tips
- Black Chevrolet bowtie emblems
- Heated power-adjustable mirrors with gloss Black caps
- Sporty Jet Black cloth and leatherette seating surfaces with Red accents
- Leather-wrapped flat-bottom steering wheel
- Leather-wrapped shift knob with RS logo

¹ Vehicle user interface is a product of Apple and its terms and privacy statements apply. Requires compatible iPhone and data plan rates apply. ² Vehicle user interface is a product of Google and its terms and privacy statements apply. Requires the Android Auto app on Google Play and a compatible Android smartphone. Data plan rates apply. You can check which smartphones are compatible at g.co/androidauto/requirements. ³ Chevrolet Infotainment System functionality varies by model. Full functionality requires compatible Bluetooth and smartphone, and USB connectivity for some devices. ⁴ Requires available Premium Seating Package. ⁵ Body-color roof available with Summit White (ACTIV only) and Mosaic Black Metallic (RS only) exterior colors.

Apple CarPlay, iPhone, Siri and Apple Music are trademarks of Apple Inc., registered in the U.S. and other countries. Android, Google Play and Android Auto are trademarks of Google LLC.

LS EXTERIOR COLORS



Summit White



Iridescent Pearl Tricoat¹



Satin Steel Metallic



Crimson Metallic



Mahogany Red Metallic



Vivid Orange Metallic¹



Blue Glow Metallic



Mosaic Black Metallic

¹Extra-cost color.

LS FEATURES



Select standard features:

MECHANICAL

Driver Mode Selector (AWD models)

Engine – ECOTEC 1.2L Turbo with Variable Valve Timing (VVT), Direct Injection and Automatic Stop/Start with override (FWD models)
 – ECOTEC 1.3L Turbo with Variable Valve Timing (VVT), Direct Injection and Automatic Stop/Start with override (AWD models)

Transmission – Continuously Variable Transmission (CVT) with Driver Shift Control (FWD models)
 – 9-speed automatic (AWD models)

EXTERIOR

Headlamps – halogen, automatic on/off with automatic delay

Mirrors – power-adjustable, manual-folding with Black caps

Tires – P225/60R17 all-season

Wipers – front variable-speed, intermittent with washers; rear intermittent with washer

INTERIOR

Air conditioning – electronic, single-zone

Door locks – power programmable with lockout protection and manual rear door child security

Entertainment – Chevrolet Infotainment 3 system¹ with 7-inch diagonal color touch-screen

Media – USB ports²; one Type-A and one Type-C, and auxiliary input jack in front center stack storage area

Seat – driver 6-way manual adjuster
 – front passenger flat-folding seatback
 – rear manual-folding 40/60 split-bench

SiriusXM^{®3} – 3-month trial subscription

Steering column – manual tilt and telescopic

Steering wheel – 3-spoke with mounted audio, phone and Driver Information Center controls

Windows – power with driver express-up/-down, all others express-down

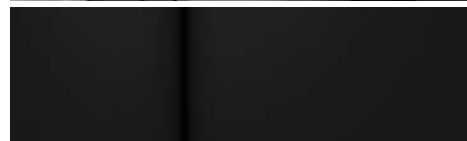

Jet Black Cloth

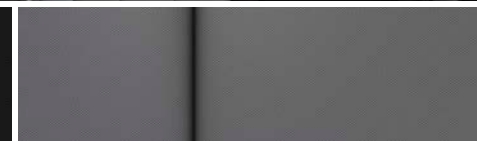

Medium Ash Gray Cloth (shown)



17" Silver-Painted Aluminum Wheels (Q6W)
 Standard on LS

¹ Chevrolet Infotainment System functionality varies by model. Full functionality requires compatible Bluetooth and smartphone, and USB connectivity for some devices. ² Not compatible with all devices. ³ If you decide to continue service after your trial, your selected subscription plan will automatically renew thereafter. You will be charged at then-current rates. Fees and taxes apply. To cancel you must call SiriusXM at 1-866-635-2349. See SiriusXM Customer Agreement for complete terms at siriusxm.com. All fees and programming subject to change.

LT EXTERIOR COLORS



Summit White



Iridescent Pearl Tricoat¹



Satin Steel Metallic



Crimson Metallic



Mahogany Red Metallic



Vivid Orange Metallic¹



Blue Glow Metallic



Mosaic Black Metallic

¹Extra-cost color.

LT FEATURES



Select standard features:

MECHANICAL

Driver Mode Selector (AWD models)

Engine – ECOTEC 1.2L Turbo with Variable Valve Timing (VVT), Direct Injection and Automatic Stop/Start with override (FWD models)
 – ECOTEC 1.3L Turbo with Variable Valve Timing (VVT), Direct Injection and Automatic Stop/Start with override (AWD models)

Transmission – Continuously Variable Transmission (CVT) with Driver Shift Control (FWD models)
 – 9-speed automatic (AWD models)

EXTERIOR

Fascia – front and rear lower, Silver-painted

Fog lamps – LED

Glass – deep-tinted rear windows and liftgate

Mirrors – heated, power-adjustable, manual-folding with body-color caps

Roof rails – Silver-painted

INTERIOR

Cruise control – electronic with Set and Resume Speed

Entertainment – Chevrolet Infotainment 3 system¹ with 7-inch diagonal color touch-screen

Keyless Open and Start – includes extended-range Remote Keyless Entry

Remote vehicle starter system

Seat – driver 8-way power adjuster with 2-way power lumbar control

SiriusXM² – 3-month trial subscription

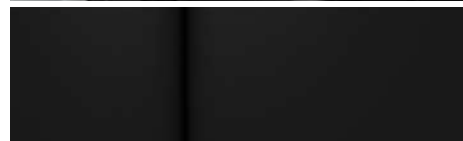
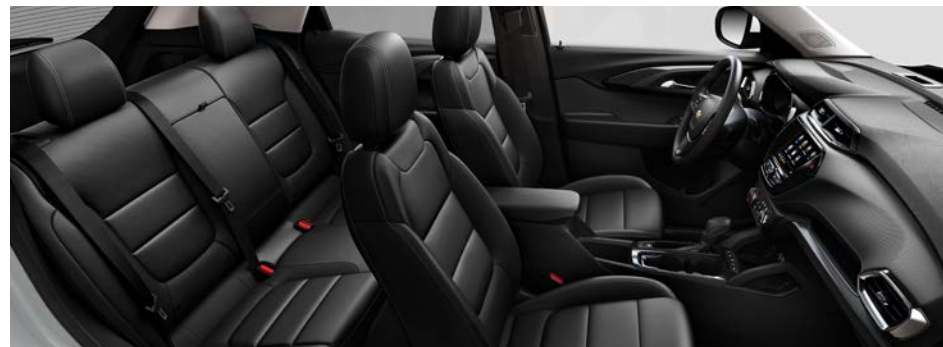

Jet Black Cloth

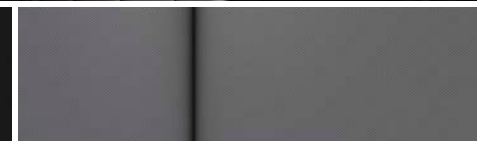

Medium Ash Gray Cloth

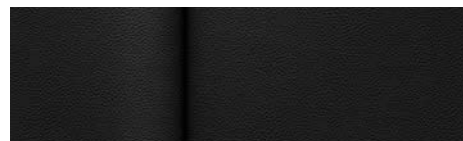

Jet Black Leatherette Seating Surfaces³ (shown)

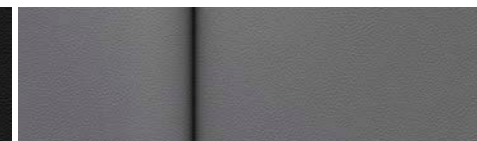

Medium Ash Gray Leatherette Seating Surfaces³



17" High-Gloss Black Machined-Aluminum Wheels (Q6V)
Standard on LT



18" Aluminum Wheels (RT1)
Available on LT

¹ Chevrolet Infotainment System functionality varies by model. Full functionality requires compatible Bluetooth and smartphone, and USB connectivity for some devices. ² If you decide to continue service after your trial, your selected subscription plan will automatically renew thereafter. You will be charged at then-current rates. Fees and taxes apply. To cancel you must call SiriusXM at 1-866-635-2349. See SiriusXM Customer Agreement for complete terms at siriusxm.com. All fees and programming subject to change. ³ Requires available Premium Seating Package.

ACTIV EXTERIOR COLORS



Summit White/Summit White



Summit White/Satin Steel Metallic



Summit White/Zeus Bronze Metallic



Summit White/Vivid Orange Metallic¹



Summit White/Blue Glow Metallic



Summit White/Mosaic Black Metallic



Zeus Bronze Metallic/Summit White



Zeus Bronze Metallic/Iridescent Pearl Tricoat¹



Zeus Bronze Metallic/Mosaic Black Metallic

¹Extra-cost color.

ACTIV FEATURES



Select standard features:

MECHANICAL

Driver Mode Selector

Engine – ECOTEC 1.3L Turbo with Variable Valve Timing (VVT), Direct Injection and Automatic Stop/Start with override

Exhaust – dual-outlet with trapezoidal polished tips

Skid plate – functional

Suspension – off-road tuning

Transmission – Continuously Variable Transmission (CVT) with Driver Shift Control (FWD models)
– 9-speed automatic (AWD models)

EXTERIOR

Fascia – front and rear lower, titanium chrome-plated

Fog lamps – LED

Glass – deep-tinted rear windows and liftgate

Mirrors – heated, power-adjustable, manual-folding with roof-color caps

Roof rails – Black

Tires – P225/60R17 sport terrain

INTERIOR

Cruise control – electronic with Set and Resume Speed

Entertainment – Chevrolet Infotainment 3 system¹ with 7-inch diagonal color touch-screen

Keyless Open and Start – includes extended-range Remote Keyless Entry

Remote vehicle starter system

Seat – driver 8-way power adjuster with 2-way power lumbar control

SiriusXM^{®2} – 3-month trial subscription

Steering wheel – 3-spoke, leather-wrapped



Jet Black Leatherette Seating Surfaces with Arizona Accents

Jet Black Leatherette Seating Surfaces with Almond Butter Accents (shown)



17" High-Gloss Black Machined-Aluminum Wheels (MZD)
Standard on ACTIV

¹ Chevrolet Infotainment System functionality varies by model. Full functionality requires compatible Bluetooth and smartphone, and USB connectivity for some devices. ² If you decide to continue service after your trial, your selected subscription plan will automatically renew thereafter. You will be charged at then-current rates. Fees and taxes apply. To cancel you must call SiriusXM at 1-866-635-2349. See SiriusXM Customer Agreement for complete terms at siriusxm.com. All fees and programming subject to change.

Some features shown may have limited, late or no availability. See dealer for feature availability.

RS EXTERIOR COLORS



Mosaic Black Metallic/Summit White



Mosaic Black Metallic/Iridescent Pearl Tricoat¹



Mosaic Black Metallic/Satin Steel Metallic



Mosaic Black Metallic/Crimson Metallic



Mosaic Black Metallic/Oasis Blue



Mosaic Black Metallic/Mosaic Black Metallic



Crimson Metallic/Satin Steel Metallic



Crimson Metallic/Mosaic Black Metallic

¹Extra-cost color.

RS FEATURES



Select standard features:

MECHANICAL

Driver Mode Selector

Engine – ECOTEC 1.3L Turbo with Variable Valve Timing (VVT), Direct Injection and Automatic Stop/Start with override

Exhaust – dual-outlet with round polished tips

Transmission – Continuously Variable Transmission (CVT) with Driver Shift Control (FWD models)
– 9-speed automatic (AWD models)

EXTERIOR

Chevrolet bowtie emblems – Black

Fascia – front and rear, Black

Fog lamps – LED

Glass – deep-tinted rear windows and liftgate

Mirrors – heated, power-adjustable, manual-folding with gloss Black caps

Roof rails – Black

Tires – P225/55R18 all-season

INTERIOR

Cruise control – electronic with Set and Resume Speed

Entertainment – Chevrolet Infotainment 3 system¹ with 7-inch diagonal color touch-screen

Keyless Open and Start – includes extended-range Remote Keyless Entry

Remote vehicle starter system

Seat – driver 8-way power adjuster with 2-way power lumbar control

SiriusXM^{®2} – 3-month trial subscription

Steering wheel – flat-bottom, leather-wrapped

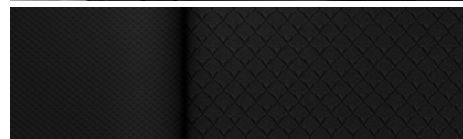
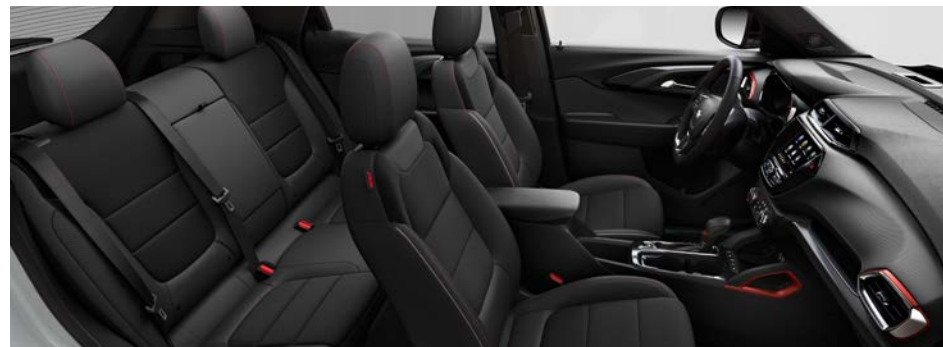

Jet Black Cloth/Leatherette Seating Surfaces with Red Accents



18" High-Gloss Black Machined-Aluminum Wheels (PZW)
Standard on RS

¹ Chevrolet Infotainment System functionality varies by model. Full functionality requires compatible Bluetooth and smartphone, and USB connectivity for some devices. ² If you decide to continue service after your trial, your selected subscription plan will automatically renew thereafter. You will be charged at then-current rates. Fees and taxes apply. To cancel you must call SiriusXM at 1-866-635-2349. See SiriusXM Customer Agreement for complete terms at siriusxm.com. All fees and programming subject to change.

Some features shown may have limited, late or no availability. See dealer for feature availability.

SPECIFICATIONS

● STANDARD ○ AVAILABLE – NOT AVAILABLE

	LS	LT	ACTIV	RS
SAFETY AND DRIVER ASSISTANCE				
Chevy Safety Assist ¹	●	●	●	●
Automatic Emergency Braking	●	●	●	●
Front Pedestrian Braking	●	●	●	●
Lane Keep Assist with Lane Departure Warning	●	●	●	●
Forward Collision Alert	●	●	●	●
IntelliBeam, auto high beams	●	●	●	●
Following Distance Indicator	●	●	●	●
Airbags ² – frontal and knee airbags for driver and front passenger; seat-mounted side-impact airbags and head-curtain airbags for front and rear outboard seating positions; includes Passenger Sensing System for passenger-side frontal and knee airbags	●	●	●	●
Lane Change Alert with Side Blind Zone Alert ¹ (requires available Driver Confidence and Cruise Package on LS; requires available Driver Confidence Package on LT, ACTIV and RS)	○	○	○	○
LATCH system (Lower Anchors and Tethers for CHildren) – for child restraint systems	●	●	●	●
Rear Cross Traffic Alert ¹ (requires available Driver Confidence and Cruise Package on LS; requires available Driver Confidence Package on LT, ACTIV and RS)	○	○	○	○
Rear Park Assist ¹ (requires available Driver Confidence and Cruise Package on LS; requires available Driver Confidence Package on LT, ACTIV and RS; models built on or after January 10, 2022, Rear Park Assist feature will not function without dealer retrofit, expected Q4 2022; see dealer for details)	○	○	○	○
Rear Vision Camera ¹	●	●	●	●
HD Rear Vision Camera ¹ (requires available Technology Package)	–	–	○	○
Teen Driver technology	●	●	●	●
Theft-deterrent system – unauthorized entry	●	●	●	●
Tire Pressure Monitoring System – with Tire Fill Alert (does not monitor spare tire)	●	●	●	●
Up to 3 months of OnStar [®] Safety & Security coverage ³	●	●	●	●

	LS	LT	ACTIV	RS
MECHANICAL				
Air filter – engine air filter monitor	●	●	●	●
Brakes – 4-wheel antilock, 4-wheel disc with Duralife [®] rotors; electronic parking brake	●	●	●	●
Drive – front-wheel drive (FWD)	●	●	●	●
– all-wheel drive (AWD)	○	○	○	○
Driver Mode Selector (requires available ECOTEC 1.3L Turbo engine on LS and LT)	○	○	●	●
Engine – ECOTEC 1.2L Turbo with Variable Valve Timing (VVT), Direct Injection and Automatic Stop/Start with override; 137 hp @ 5000 rpm, 162 lb.-ft. of torque @ 2500 rpm	●	●	–	–
– ECOTEC 1.3L Turbo with Variable Valve Timing (VVT), Direct Injection and Automatic Stop/Start with override; 155 hp @ 5600 rpm, 174 lb.-ft. of torque @ 1600 rpm (available on LT FWD; included on LS and LT AWD)	○	○	●	●
Exhaust – dual-outlet with trapezoidal polished tips	–	–	●	–
– dual-outlet with round polished tips	–	–	–	●
Skid plate – functional	–	–	●	–
StabiliTrak [®] – Electronic Stability Control System with Traction Control; includes Hill Start Assist	●	●	●	●
Steering – power, electric, rack-and-pinion	●	●	●	●
Suspension – front MacPherson strut	●	●	●	●
– rear compound crank	●	●	●	●
– rear Watts link (AWD models)	○	○	○	○
– off-road tuning	–	–	●	–
Trailer provisions (requires available ECOTEC 1.3L Turbo engine on LT FWD; included on LS and LT AWD)	○	○	●	●
Transmission – Continuously Variable Transmission (CVT) with Driver Shift Control (FWD models)	●	●	●	●
– 9-speed automatic, electronically controlled with overdrive and Driver Shift Control (AWD models)	○	○	○	○

¹ Safety or driver assistance features are no substitute for the driver's responsibility to operate the vehicle in a safe manner. Read the vehicle Owner's Manual for important feature limitations and information. ² A NOTE ON CHILD SAFETY: Always use seat belts and the correct child restraint for your child's age and size, even with airbags. Even in vehicles equipped with the Passenger Sensing System, children are safer when properly secured in a rear seat in the appropriate infant, child or booster seat. Never place a rear-facing infant restraint in the front seat of any vehicle equipped with an active frontal airbag. See your vehicle Owner's Manual and the child safety seat instructions for more safety information. ³ When you select a monthly plan within 30 days of activating your 1-month trial, you'll receive the next 2 months of the plan you select at no additional charge when you associate an approved payment method on file to your account and authorize recurring payments for your service plan. The amount and frequency of each recurring payment is based upon the service(s) and payment interval(s) you select from the options provided. After the trial expires, OnStar will automatically bill your payment method monthly at then-current standard monthly rates. Plans containing 4G LTE data will be billed every 30 days by AT&T. You may cancel at any time by pushing your blue OnStar button or calling 1-888-466-7827. May not be combined with other offers or retroactively applied. Offer subject to change.

SPECIFICATIONS (CONTINUED)

● STANDARD ○ AVAILABLE – NOT AVAILABLE

	LS	LT	ACTIV	RS
EXTERIOR				
Active aero shutters – lower grille	●	●	●	●
Chevrolet bowtie emblems – Black	–	–	–	●
Daytime running lamps – LED	●	●	●	●
Fascia – front and rear lower, Black	●	–	–	●
– front and rear lower, Silver-painted	–	●	–	–
– front and rear, titanium chrome-plated	–	–	●	–
Fog lamps – LED	–	●	●	●
Fuel filler cap – locking	●	●	●	●
Glass – solar-absorbing	●	●	●	●
– deep-tinted rear windows and liftgate	–	●	●	●
Headlamps – halogen with automatic on/off	●	●	●	●
– LED (requires available Technology Package)	–	–	○	○
– IntelliBeam with automatic high beam on/off	●	●	●	●
Liftgate – rear, manual	●	●	●	●
– power, programmable, hands-free with LED logo projection (requires available Sun and Liftgate Package, Convenience Package and Driver Confidence Package; requires available ECOTEC 1.3L Turbo engine on LT FWD)	–	○	○	○
Mirrors – power-adjustable, manual-folding with Black caps	●	–	–	–
– heated, power-adjustable, manual-folding with body-color caps	–	●	–	–
– heated, power-adjustable, manual-folding with roof-color caps	–	–	●	–
– heated, power-adjustable, manual-folding with gloss Black caps	–	–	–	●
Roof, one-tone – Summit White (requires Summit White exterior color)	–	–	○	–
– Mosaic Black Metallic (requires Mosaic Black Metallic exterior color)	–	–	–	○
Roof, two-tone – Summit White (requires Satin Steel Metallic, Vivid Orange Metallic, Zeus Bronze Metallic, Blue Glow Metallic or Mosaic Black Metallic exterior color)	–	–	○	–
– Zeus Bronze Metallic (requires Summit White, Iridescent Pearl Tricoat ¹ or Mosaic Black Metallic exterior color)	–	–	○	–
– Mosaic Black Metallic (requires Summit White, Iridescent Pearl Tricoat ¹ , Satin Steel Metallic, Crimson Metallic or Oasis Blue exterior color)	–	–	–	○
– Crimson Metallic (requires Satin Steel Metallic or Mosaic Black Metallic exterior color)	–	–	–	○
Roof rails – Silver-painted	–	●	–	–
– Black	–	–	●	●
Taillamps – halogen	●	●	–	–
– LED	–	–	●	●
Tires – 225/65R17 all-season	●	●	–	–
– 225/60R17 sport terrain	–	–	●	–
– 225/55R18 all-season (requires available 18" aluminum wheels on LT)	–	○	–	–
– compact spare	●	●	●	●

	LS	LT	ACTIV	RS
EXTERIOR (CONTINUED)				
Wheels – 17" Silver-painted aluminum (Q6W)	●	–	–	–
– 17" high-gloss Black machined-aluminum (Q6V)	–	●	–	–
– 17" high-gloss Black machined-aluminum (MZD)	–	–	●	–
– 18" high-gloss Black machined-aluminum (PZW)	–	–	–	●
– 18" aluminum (RT1)	–	○	–	–
Wipers – front variable-speed, intermittent; rear intermittent with washer	●	●	●	●
INTERIOR				
Active Noise Cancellation (AWD models)	○	○	○	○
Air conditioning – electronic, single-zone	●	●	●	●
– automatic, single-zone with cabin humidity sensor (requires available Convenience Package and Driver Confidence Package)	–	○	○	○
Air filter – cabin	●	●	●	●
Armrest – rear-seat center (requires available Premium Seating Package, Convenience Package and Driver Confidence Package or Adaptive Cruise Control Package, Convenience Package and Driver Confidence Package on LT)	–	○	●	●
Assist handles – overhead, all outboard seating positions	●	●	●	●
Compass display – located in Driver Information Center	●	●	●	●
Cruise control – electronic with Set and Resume Speed (requires available Driver Confidence and Cruise Package on LS)	○	●	●	●
– Adaptive Cruise Control ² (requires available Adaptive Cruise Control Package, Convenience Package and Driver Confidence Package on LT; requires available Technology Package, Convenience Package and Driver Confidence Package on ACTIV and RS)	–	○	○	○
Door locks – power programmable with lockout protection and manual rear door child security	●	●	●	●
Driver Information Center – 3.5-inch diagonal monochromatic display	●	●	●	●
– 4.2-inch diagonal multi-color display (requires available Adaptive Cruise Control Package, Convenience Package and Driver Confidence Package on LT; requires available Technology Package, Convenience Package and Driver Confidence Package on ACTIV and RS)	–	○	○	○
Floor mats – front and rear	●	●	●	●
Lighting – overhead courtesy, dual reading lamps, rear courtesy and cargo area	●	●	●	●
Mirror – rearview, manual day/night	●	●	●	●
– rearview, auto-dimming (requires available Convenience Package and Driver Confidence Package)	–	○	○	○
Power outlet – 120-volt, on rear of center console (requires available Convenience Package and Driver Confidence Package)	–	○	○	○
Remote Keyless Entry – with panic alarm	●	●	●	●
– Keyless Open and Start, includes extended-range Remote Keyless Entry	–	●	●	●
Remote vehicle starter system	–	●	●	●

¹ Extra-cost color. ² Safety or driver assistance features are no substitute for the driver's responsibility to operate the vehicle in a safe manner. Read the vehicle Owner's Manual for important feature limitations and information.

SPECIFICATIONS (CONTINUED)

● STANDARD ○ AVAILABLE – NOT AVAILABLE

	LS	LT	ACTIV	RS
INTERIOR (CONTINUED)				
Shift knob – Satin Silver and chrome – leather-wrapped, Satin Silver and chrome (requires available Premium Seating Package, Convenience Package and Driver Confidence Package or Adaptive Cruise Control Package, Convenience Package and Driver Confidence Package on LT)	●	●	–	–
Steering column – manual tilt and telescopic	●	●	●	●
Steering wheel – 3-spoke with mounted audio, phone and Driver Information Center controls – 3-spoke, leather-wrapped (requires available Premium Seating Package, Convenience Package and Driver Confidence Package or Adaptive Cruise Control Package, Convenience Package and Driver Confidence Package on LT)	●	●	●	●
– 3-spoke, Sport, leather-wrapped with contrasting stitching, Black bowtie emblem and flat-bottom design	–	○	●	–
– 3-spoke, heated (requires available Premium Seating Package, Convenience Package and Driver Confidence Package or Adaptive Cruise Control Package, Convenience Package and Driver Confidence Package on LT; models built on or after November 22, 2021, feature will not function without dealer retrofit, expected Q3 2022; see dealer for details)	–	○	○	○
Sunroof – panoramic power with power sunshade (requires available Sun and Liftgate Package, Convenience Package and Driver Confidence Package; requires available ECOTEC 1.3L Turbo engine on LT FWD)	–	○	○	○
Visors – driver and front passenger, covered vanity mirrors – driver and front passenger, covered vanity mirrors, sliding – driver and front passenger, covered illuminated vanity mirrors, sliding (requires available Convenience Package and Driver Confidence Package)	●	–	–	–
Windows – power with driver express-up/-down, all others express-down	●	●	●	●
SEATING				
Seats – front bucket – rear manual-folding 40/60 split-bench – rear manual-folding 40/60 split-bench with center armrest (requires available Premium Seating Package, Convenience Package and Driver Confidence Package or Adaptive Cruise Control Package, Convenience Package and Driver Confidence Package on LT)	●	●	●	●
Seat – driver 6-way manual adjuster – driver 8-way power adjuster with 2-way power lumbar control – front passenger flat-folding seatback	●	–	–	–
Heated driver and front passenger seats (models built on or after November 15, 2021, feature will not function without dealer retrofit, expected Q2 2022; see dealer for details)	–	○	○	○

	LS	LT	ACTIV	RS
ENTERTAINMENT				
Chevrolet Infotainment 3 system ¹ with 7-inch diagonal color touch-screen, AM/FM stereo, Bluetooth [®] audio streaming ² for two active devices, voice command pass-through to compatible phone, and wireless Apple CarPlay ^{®3} and wireless Android Auto ^{™4} compatibility	●	●	●	●
Chevrolet Infotainment 3 system ¹ with 8-inch diagonal color touch-screen, AM/FM stereo, Bluetooth audio streaming ² for two active devices, voice command pass-through to compatible phone, and wireless Apple CarPlay ^{®2} and wireless Android Auto ^{™4} compatibility (requires available Convenience Package and Driver Confidence Package)	–	○	○	○
Chevrolet Infotainment 3 Plus system ¹ with 8-inch diagonal HD color touch-screen, AM/FM stereo, Bluetooth audio streaming ² for two active devices, voice command pass-through to compatible phone, wireless Apple CarPlay ^{®2} and wireless Android Auto ^{™4} compatibility, available Alexa Built-In ⁵ voice recognition, In-Vehicle Apps ⁶ (requires available Technology Package, Convenience Package and Driver Confidence Package) and Chevrolet Maps+ ⁷	–	–	○	○
Audio – 6-speaker system – Bose premium 7-speaker audio system (requires available Technology Package, Convenience Package and Driver Confidence Package)	●	●	●	●
Media – USB ports ⁸ (one Type-A and one Type-C), 12-volt power outlet, and auxiliary input jack in front center stack storage area – USB ports ⁸ (one Type-A and one Type-C), charge-only, on rear of center console (requires available Convenience Package and Driver Confidence Package)	●	●	●	●
HD Radio [®] (requires available Technology Package, Convenience Package and Driver Confidence Package)	–	–	○	○
SiriusXM ^{®9} – 3-month trial subscription SiriusXM with 360L ^{9,10} – 3-month trial subscription (requires available Technology Package, Convenience Package and Driver Confidence Package)	●	●	●	●
Available Wi-Fi [®] Hotspot ¹¹ for up to seven devices, includes 1 month of unlimited data	○	○	○	○
Chevrolet Connected Access ¹² with up to 10 years of standard connectivity, which currently enables features such as Vehicle Diagnostics and Dealer Maintenance Notification	●	●	●	●
Wireless charging ¹³ (requires available Technology Package, Convenience Package and Driver Confidence Package)	–	–	○	○

¹ Chevrolet Infotainment System functionality varies by model. Full functionality requires compatible Bluetooth and smartphone, and USB connectivity for some devices. ² Go to my.chevrolet.com/learnAbout/bluetooth to find out which phones are compatible with the vehicle. Full Bluetooth feature functionality varies by device, model and software version. ³ Vehicle user interface is a product of Apple and its terms and privacy statements apply. Requires compatible iPhone and data plan rates apply. ⁴ Vehicle user interface is a product of Google and its terms and privacy statements apply. Requires the Android Auto app on Google Play and a compatible Android smartphone. Data plan rates apply. You can check which smartphones are compatible at g.co/androidauto/requirements. ⁵ Functionality is subject to limitations and varies by vehicle, infotainment system and location. Select service plan required. Certain Alexa Skills require account linking to use. Visit onstar.com for additional details. ⁶ Third-party trademarks are the property of their respective third-party owners and used under agreement. Requires active service plan and paid AT&T vehicle data plan. Visit onstar.com for details and limitations. ⁷ U.S. only. Requires select service plan. Functionality is subject to user terms and limitations and varies by vehicle model. Visit onstar.com for details and limitations. ⁸ Not compatible with all devices. ⁹ If you decide to continue service after your trial, your selected subscription plan will automatically renew thereafter. You will be charged at then-current rates. Fees and taxes apply. To cancel you must call SiriusXM at 1-866-635-2349. See SiriusXM Customer Agreement for complete terms at siriusxm.com. All fees and programming subject to change. ¹⁰ Certain features require a SiriusXM subscription and the Chevrolet Connected Access plan. See siriusxm.com and onstar.com for details and limitations. ¹¹ Service varies with conditions and location. Requires active service and paid AT&T data plan. Visit onstar.com for details and limitations. Availability subject to change. ¹² Standard connectivity available only to original purchaser for up to 10 years. Connected Access services are subject to change. Does not include emergency or security services. Diagnostic capabilities vary by model and service plan. Message and data rates may apply. Requires contact method on file and enrollment to receive alerts. Not all issues will deliver alerts. Visit onstar.com for details and limitations. ¹³ The system wirelessly charges one compatible mobile device. Some phones have built-in wireless charging technology and others require a special adaptor/back cover. To check for phone or other device compatibility, see my.chevrolet.com/learn or consult your carrier.

SPECIFICATIONS (CONTINUED)

● STANDARD ○ AVAILABLE – NOT AVAILABLE

	LS	LT	ACTIV	RS
PACKAGES				
Driver Confidence and Cruise Package	○	-	-	-
Electronic cruise control with Set and Resume Speed, Lane Change Alert with Side Blind Zone Alert ¹ ; Rear Cross Traffic Alert ¹ and Rear Park Assist ¹ (models built on or after January 10, 2022, Rear Park Assist feature will not function without dealer retrofit, expected Q4 2022; see dealer for details)				
Adaptive Cruise Control Package	-	○	-	-
Adaptive Cruise Control ¹ ; Driver Information Center with 4.2-inch diagonal multi-color display, leather-wrapped steering wheel, leather-wrapped shift knob, rear-seat center armrest and heated steering wheel (heated steering wheel will not function on certain models without dealer retrofit, expected Q3 2022; see dealer for details) (requires available Convenience Package and Driver Confidence Package)				
Premium Seating Package	-	○	-	-
Leatherette seating surfaces, leather-wrapped steering wheel, leather-wrapped shift knob, rear-seat center armrest and heated steering wheel (heated steering wheel will not function on certain models without dealer retrofit, expected Q3 2022; see dealer for details) (requires available Convenience Package and Driver Confidence Package)				
Convenience Package	-	○	○	○
Single-zone automatic climate control, Chevrolet Infotainment 3 system ² with 8-inch diagonal color touch-screen, 120-volt power outlet on rear of center console, charge-only USB ports ³ (one Type-A and one Type-C) on rear of center console, inside rearview auto-dimming mirror, and driver and front passenger illuminated vanity mirrors (requires available Driver Confidence Package)				
Driver Confidence Package	-	○	○	○
Lane Change Alert with Side Blind Zone Alert ¹ ; Rear Cross Traffic Alert ¹ and Rear Park Assist ¹ (models built on or after January 10, 2022, Rear Park Assist feature will not function without dealer retrofit, expected Q4 2022; see dealer for details)				
Sun and Liftgate Package	-	○	○	○
Panoramic power sunroof with power sunshade and hands-free programmable power liftgate with LED logo projection (requires available Convenience Package and Driver Confidence Package; requires available ECOTEC 1.3L Turbo engine on LT FWD)				
Technology Package	-	-	○	○
Chevrolet Infotainment 3 Plus system ² with 8-inch diagonal HD color touch-screen, available Alexa Built-In ⁴ voice recognition, In-Vehicle Apps ⁵ ; HD Radio ⁶ ; SiriusXM [®] with 360L ^{6,7} 3-month trial subscription, Bose premium 7-speaker audio system, SD card reader in front center floor console storage area, wireless charging ⁸ ; Adaptive Cruise Control ¹ ; HD Rear Vision Camera ¹ ; Driver Information Center with 4.2-inch diagonal multi-color display and LED headlamps (requires available Convenience Package and Driver Confidence Package)				

¹ Safety or driver assistance features are no substitute for the driver's responsibility to operate the vehicle in a safe manner. Read the vehicle Owner's Manual for important feature limitations and information. ² Chevrolet Infotainment System functionality varies by model. Full functionality requires compatible Bluetooth and smartphone, and USB connectivity for some devices. ³ Not compatible with all devices. ⁴ Functionality is subject to limitations and varies by vehicle, infotainment system and location. Select service plan required. Certain Alexa Skills require account linking to use. Visit onstar.com for additional details. ⁵ Third-party trademarks are the property of their respective third-party owners and used under agreement. Requires active service plan and paid AT&T vehicle data plan. Visit onstar.com for details and limitations. ⁶ If you decide to continue service after your trial, your selected subscription plan will automatically renew thereafter. You will be charged at then-current rates. Fees and taxes apply. To cancel you must call SiriusXM at 1-866-635-2349. See SiriusXM Customer Agreement for complete terms at siriusxm.com. All fees and programming subject to change. ⁷ Certain features require a SiriusXM subscription and the Chevrolet Connected Access plan. See siriusxm.com and onstar.com for details and limitations. ⁸ The system wirelessly charges one compatible mobile device. Some phones have built-in wireless charging technology and others require a special adaptor/back cover. To check for phone or other device compatibility, see my.chevrolet.com/learn or consult your carrier.

SPECIFICATIONS (CONTINUED)

MAXIMUM CAPACITIES

Fuel tank (approximate)	13.2 gallons
Passenger volume	98.2 cubic feet
Seating (front/rear)	Seats 2/3
Cargo volume ¹	Behind rear seats: 25.3 cubic feet Behind front seats: 54.4 cubic feet

EPA-ESTIMATED FUEL ECONOMY

1.2L Turbo FWD	29 MPG city/31 highway/30 combined
1.3L Turbo FWD	29 MPG city/33 highway/31 combined
1.3L Turbo AWD	26 MPG city/30 highway/28 combined

DIMENSIONS

A - Wheelbase	103.9"
B - Length	173.5" - LS, LT 173.7" - ACTIV, RS
C - Height	65.2" - LS, LT, ACTIV FWD 65.3" - RS FWD 65.7" - LS, LT, ACTIV, RS AWD

D - Front track	60.9"
Rear track	61.3"
E - Width	71.2"

Head room (front/rear)	40.0"/38.4"
Head room with sunroof (front/rear)	38.3"/36.8"
Leg room (front/rear)	40.9"/39.4"
Shoulder room (front/rear)	55.4"/53.8"
Hip room (front/rear)	52.3"/45.7"

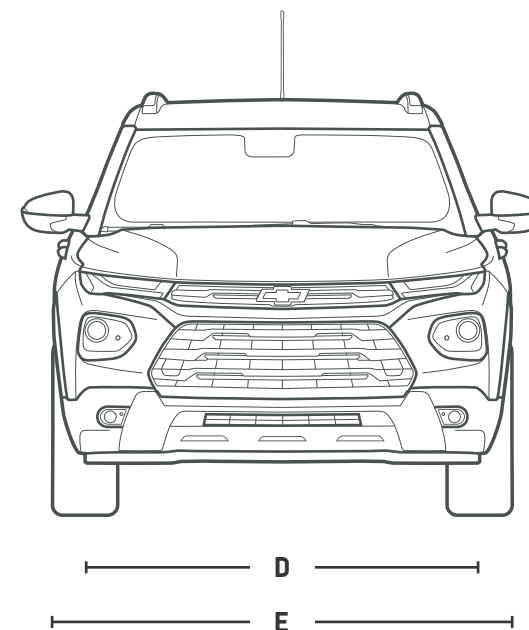
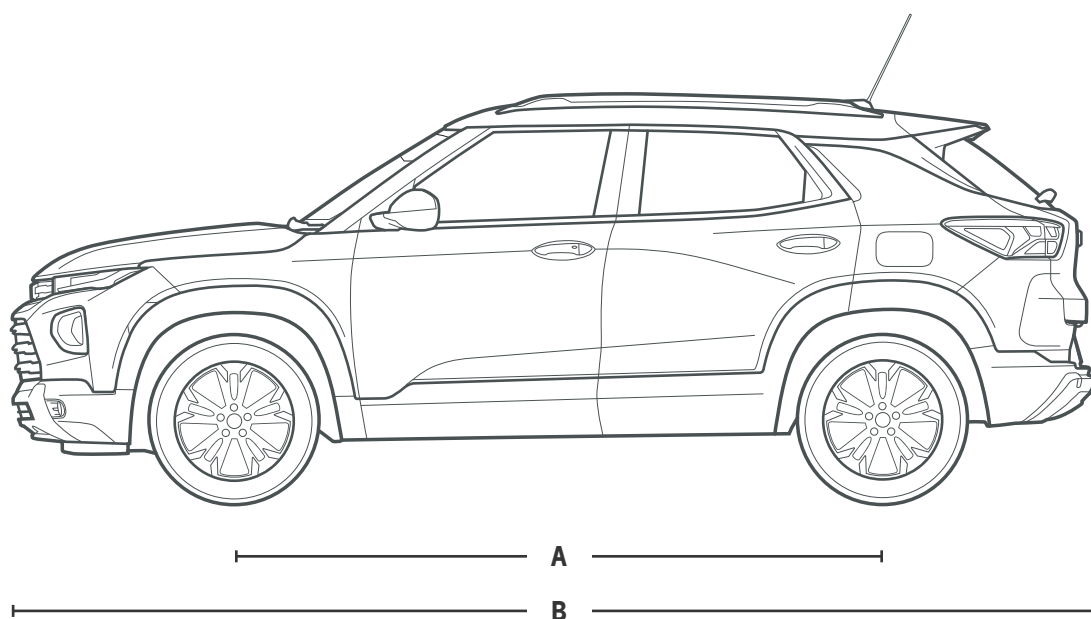

¹ Cargo and load capacity limited by weight and distribution.

ACCESSORIES



Splash Guards available from Chevrolet Accessories.



All-Weather Cargo Mat available from Chevrolet Accessories.

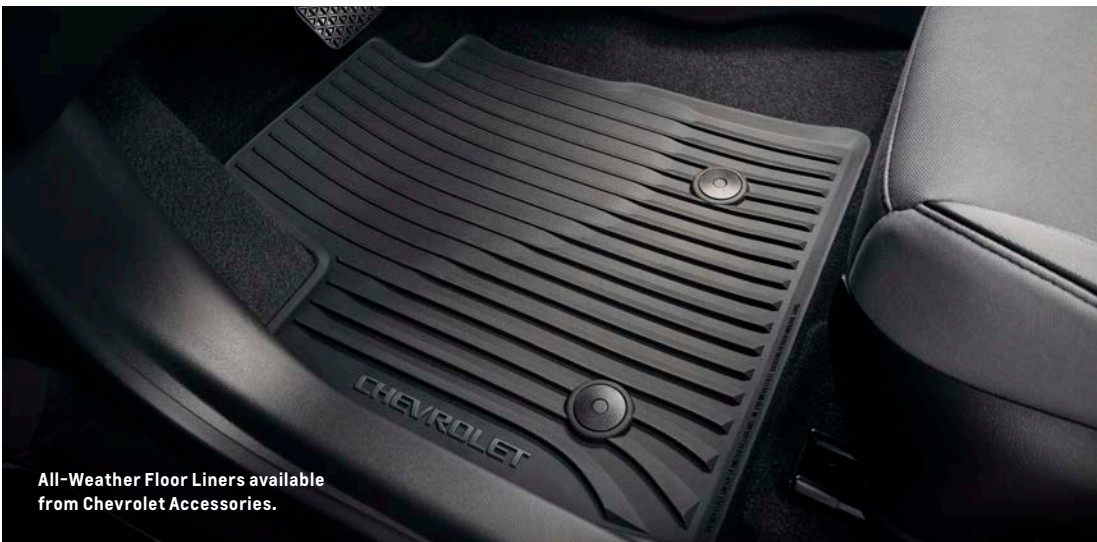

All-Weather Floor Liners available from Chevrolet Accessories.



Bowtie Emblem in Black available from Chevrolet Accessories.

IMPORTANT INFORMATION



Every step of the way.

You may be discovering Chevrolet through a personalized online shopping experience or enjoying every year of vehicle ownership. Either way, we're committed to providing the tools and programs you need to help you get the most out of your journey.

Build & Price >

Create your perfect Chevrolet from start to finish.

Chevy MyWay¹ >

Engage in a real-time virtual video experience with a Chevy product specialist.

Chevrolet Complete Care >

Enjoy an owner benefit program that provides excellent service and support from day one.

Discover My Chevrolet Rewards² >

Unlock a world of appreciation that's all about you and your Chevrolet. Start earning and redeeming today.

Limited Warranty Coverage >

Discover all the ways Chevrolet is committed to providing an excellent ownership experience.



GM, the GM logo, Chevrolet, the Chevrolet logo, and the slogans, emblems, vehicle model names, vehicle body designs and other marks appearing in this brochure are the trademarks and/or service marks of General Motors, its subsidiaries, affiliates or licensors. ©2022 OnStar LLC. All rights reserved. Sirius, XM, SiriusXM and all related marks and logos are trademarks of Sirius XM Radio Inc. Amazon, Alexa and all related marks are trademarks of Amazon.com, Inc. or its affiliates. The Bluetooth word mark is a registered trademark owned by Bluetooth SIG, Inc., and any use of such mark by Chevrolet is under license. Bose is a registered trademark of the Bose Corp.

©2022 General Motors. All rights reserved. February 2022

FIND NEW ROADS™

CHEVROLET.COM

¹ Chevy MyWay is available to anyone over 18 in the United States to access and experience via chevrolet.com/myway. ² Must be 18 years or older. Points may be earned and redeemed only at GM entities, My Chevrolet Rewards participating dealers or third party retailers in the United States (excluding Puerto Rico, the U.S. Virgin Islands or Guam). Points are not earned on taxes, fees or body shop repair orders and expire without further notice upon Member Account deactivation. Visit myChevroletrewards.com to view My GM Rewards Terms & Conditions.